

Magnetic Contactors and Starters

SC and SW series

Optional unit

■ Optional unit

Optional unit	Description	Type	Used with	Further information
Auxiliary contact block	Front mounting (Bifurcated) 4NO 3NO+1NC 2NO+2NC 2NO 1NO+1NC 2NC 2NO+2NC (Overlapping) 1NO+1NC (Overlapping)	SZ-A40 SZ-A31 SZ-A22 SZ-A20 SZ-A11 SZ-A02 SZ-A222 SZ-A111	SC-03 to N3	<i>Page 01/77</i>
	Front mounting (Single button) 4NO 3NO+1NC 2NO+2NC	SZ-A40H SZ-A31H SZ-A22H	SC-03 to N3	
	Side mounting (Bifurcated) 1NO+1NC Side mounting (Single button) 1NO+1NC 1NO+1NC 1NO+1NC 1NO+1NC	SZ-AS1 SZ-AS2 SZ-AS1H SZ-AS2H SZ-AS3H	SC-03 to N3 SC-N4 to N12 SC-03 to N3 SC-N4 to N12 SC-N14, N16	
Auxiliary contact block with quick connection terminals	4NO 3NO+1NC 2NO+2NC 2NO 1NO+1NC 2NC	SZ-A40Y SZ-A31Y SZ-A22Y SZ-A20Y SZ-A11Y SZ-A02Y	SC-03Y, 0Y, 05Y, 5-1Y	<i>Page 01/73</i>
Operation counter unit	Without alarm contact	SZ-J	SC-03 to N3	<i>Page 01/83</i>
	With alarm contact At 1 million operations At 2 million operations At 3 million operations At 4 million operations At 5 million operations At 6 million operations At 7 million operations At 8 million operations	SZ-J1 SZ-J2 SZ-J3 SZ-J4 SZ-J5 SZ-J6 SZ-J7 SZ-J8	SC-03 to 5-1	
Main circuit surge suppression unit	Front mounting Side mounting	SZ-ZM1 SZ-ZM3 SZ-ZM2 SZ-ZM4	SC-03 to 5-1 SC-N1 to N3 SC-03 to 5-1 SC-N1 to N3	<i>Page 01/81</i>
Mechanical interlock unit		SZ-RM	SC-03 to N3	<i>Page 01/82</i>
Power connection kit for reversing		SZ-RW1 SZ-RW2 SZ-RW3 SZ-RW4 SZ-RW5 SZ-RW6	SC-03, 0 SC-05 SC-4-0, 4-1 SC-5-1 SC-N1, N2 SC-N2S, N3	<i>Page 01/82</i>
Coil drive unit for IC output	Relay type Top mounting	SZ-CD1 SZ-CD3	SC-03 to 5-1 SC-N1 to N3 SC-N4 to N12	<i>Page 01/78</i>
	Left-side mounting	SZ-CD5		
	SSR type Top mounting	SZ-03/CD2-24 SZ-CD4	SC-03 to 5-1 SC-N1 to N3 SC-N4 to N12	
	Left-side mounting	SZ-CD6A		
3-pole parallel plate terminal	(2 pcs/set)	SZ-SP1 SZ-SP2 SZ-SP3 SZ-SP4 SZ-SP5	SC-03, 0, 05 SC-4-0, 4-1, 5-1 SC-N1, N2 SC-N2S, N3 SC-N4, N5	<i>Page 01/71</i>

Optional unit	Description	Type	Used with	Further information
3-pole parallel plate terminal	(2pcs/set)	SZ-SP6 SZ-SP7 SZ-SP8 SZ-SP9 SZ-SP10 SZ-SP11	SC-N6 SC-N7 SC-N8, N10 SC-N11, N12 SC-N14 SC-N16	Page 01/71
Coil surge suppression unit	Varistor 24 to 48V AC/DC 100 to 250V AC/DC 380 to 440V AC 24 to 48V AC/DC(with LED) 100 to 250V AC/DC(with LED) 24 to 48V AC/DC 100 to 250V AC/DC 380 to 440V AC 24 to 48V AC 100 to 250V AC 380 to 440V AC CR 24 to 48V AC/DC 100 to 250V AC/DC 24 to 48V AC/DC(with LED) 100 to 250V AC/DC(with LED) 24 to 48V AC 100 to 250V AC 24 to 48V DC 100 to 250V DC 24 to 48VAC 100 to 250V AC	SZ-Z1 SZ-Z2 SZ-Z3 SZ-Z6 SZ-Z7 SZ-Z31 SZ-Z32 SZ-Z33 SZ-Z41 SZ-Z42 SZ-Z43 SZ-Z4 SZ-Z5 SZ-Z8 SZ-Z9 SZ-Z34 SZ-Z35 SZ-Z36 SZ-Z37 SZ-Z44 SZ-Z45	SC-03 to 5-1, SC03/G to 5-1/G SC-03 to 5-1, SC-03/G to 5-1/G SC-03 to 5-1 SC-03 to 5-1, SC-03/G to 5-1/G SC-03 to 5-1, SC-03/G to 5-1/G SC-N1 to N3, SC-N1/G to N3/G SC-N1 to N3, SC-N1/G to N3/G SC-N1 to N3 SC-N4 SC-N4 SC-N4 SC-03 to 5-1, SC-03/G to 5-1/G SC-03 to 5-1, SC-03/G to 5-1/G SC-03 to 5-1, SC-03/G to 5-1/G SC-03 to 5-1, SC-03/G to 5-1/G SC-N1 to N3 SC-N1 to N3 SC-N1/G to N3/G SC-N1/G to N3/G SC-N4 SC-N4	Page 01/80
Contact welding detector	1NO 100 to 250V AC 1NC 100 to 250V AC	SZ-BW2A SZ-BW2B	SC-03 to N16	Page 01/79
Fault detector unit	SPDT 100 to 120V AC SPDT 200 to 240V AC	SY-F-A3/M SY-F-A4/M	SC-03 to N16	Contact FUJI
Contact transfer protector	100 to 127V AC 200 to 250V AC	SZ-RC1 SZ-RC2	SC-03 to N16	Contact FUJI
Terminal cover	For contactor For contactor For starter For reversing contactor	SZ-T1 SZ-T2 SZ-T3 SZ-T4 SZ-T22 SZ-T23 SZ-N4T SZ-N6T SZ-N7T SZ-N8T SZ-N11T SZ-N4T, SZ-WN4T SZ-N6T, SZ-WN6T SZ-N7T, SZ-WN7T SZ-N8T, SZ-WN8T SZ-N8T, SZ-WN10T SZ-N11T, SZ-WN11T SZ-N4RT1, T2 SZ-N6RT1, T2 SZ-N7RT1, T2 SZ-N8RT1, T2 SZ-N11RT1, T2	SC-03, 0 SC-05 SC-4-0, 4-1 SC-5-1 SC-N1, N2 SC-N2S, N3 SC-N4, N5 SC-N6 SC-N7 SC-N8, N10 SC-N11, N12 SW-N4/3H, N5/3H SW-N6/3H SW-N7/3H SW-N8/3H SW-N10/3H SW-N11/3H, N12/3H SW-N4RM, N5RM SW-N6RM SW-N7RM SW-N8RM, N10RM SW-N11RM, N12RM	Page 01/84

Magnetic Contactors and Starters
SC and SW series
Optional unit

Optional unit	Description	Type	Used with	Further information
Terminal cover	For thermal overload relay For auxiliary contact block For 4-pole front mount For 2-pole front mount For 1-pole front mount	SZ-T10 SZ-T11 SZ-T12 SZ-T13 SZ-T14 SZ-T15 SZ-RN6T SZ-T16 SZ-T17 SZ-T5 SZ-T6 SZ-T7	SZ-HB SZ-HC TR-0N/3, TK-0N TR-5-1N/3, TK-5-1N TR-N2H/3, TK-N2H TR-N3H/3, TK-N3H TR-N6H/3, TKN6H TR-N2/3, TK-N2 TR-N3/3, TK-N3 SZ-A40, A31, A22, A222 SZ-A20, A11, A02, A111 SZ-AS1, AS2	Page 01/84
Insulation barrier	For contactor	SZ-B1 SZ-B2	SC(SW)-N4 to N7, TR(TK)-N6H SC(SW)-N8 to N12, TR(TK)N10H/3 to N12H/3	Page 01/85
Off-delay release unit	100V AC 50/60Hz 110V AC 50/60Hz 200V AC 50/60Hz 220V AC 50/60Hz 100-110V AC, 50/60Hz 200-220V AC, 50/60Hz	SZ-DE100 SZ-DE110 SZ-DE200 SZ-DE220 SZ-N1/GDE SZ-N2S/GDE SZ-N5/DE SZ-N6/DE SZ-N8/DE SZ-N11/DE SZ-N14/DE SZ-N1/GDE SZ-N2S/GDE SZ-N5/DE SZ-N6/DE SZ-N8/DE SZ-N11/DE	SC-03/G to 5-1/G SC-N1/G, N2/G SC-N2S/G, N3/G SC-N4/SE, N5 SC-N6, N7 SC-N8, N10 SC-N11, N12 SC-N14 SC-N1/G, N2/G SC-N2S/G, N3/G SC-N4/SE, N5 SC-N6, N7 SC-N8, N10 SC-N11, N12	Page 01/54
Live-section cover	For contactor For starter For reversing starter	SZ-JC1 SZ-JC2 SZ-JC3 SZ-JC4 SZ-N1J SZ-N2SJ SZ-N4J SZ-N6J SZ-N7J SZ-N8J SZ-N11J SZ-JW1 SZ-JW2 SZ-JW3 SZ-JW4 SZ-WN1J SZ-WN2SJ SZ-WN4J SZ-WN6J SZ-WN7J SZ-WN8J SZ-WN10J SZ-WN11J SZ-WN4RJ SZ-WN6RJ SZ-WN7RJ SZ-WN8RJ SZ-WN10RJ SZ-WN11RJ	SC-03, 0 SC-05 SC-4-0, 4-1 SC-5-1 SC-N1, N2 SC-N2S, N3 SC-N4, N5 SC-N6 SC-N7 SC-N8, N10 SC-N11, N12 SW-03/3H, 0/3H SW-05/3H SW-4-0/3H, 4-1/3H SW-5-1/3H SW-N1/3H, N2/3H SW-N2S/3H, N3/3H SW-N4/3H, N5/3H SW-N6/3H SW-N7/3H SW-N8/3H SW-N10/3H SW-N11/3H, N12/3H SW-N4RM, N5RM SW-N6RM SW-N7RM SW-N8RM SW-N10RM SW-N11RM, N12RM	Page 01/86

Magnetic Contactors and Starters

SC and SW series

Optional unit

Coil drive units for IC output SZ-CD

This unit is designed to carry out ON-OFF control for contactors with output (24V DC) from the electronic controller. It can be attached to a side or top of a contactor, thus saving on installation space.

■ Features

- This unit operates at, 24V DC.
- Module type allows easy attachment and removal.
- SZ-CD5 and -CD6 can be installed individually and rail mounted.
- Surge suppression function (except SZ-CD5)
- This unit has a built-in surge suppression device (varistor) to protect electronic equipment from surges which occur when the coil is de-energized.



SZ-CD1

Type		Used with
SZ-CD1 SZ-CD3 SZ-CD5	With relay output	SC-03 to 5-1 SC-N1 to N3 SC-N4 to N12
SZ-03/CD2-24 SZ-CD4 SZ-CD6	With SSR output	SC-03 to 5-1 SC-N1 to N3 SC-N4 to N12

■ Specifications

Description		SZ-CD1	SZ-CD3, CD5	SZ-03/CD2-24, CD4, CD6
Coil	Rated voltage	24V DC	24V DC	24V DC
	Pick-up voltage (at 20°C)	85% or less of rated voltage	85% or less of rated voltage	70% or less of rated voltage
	Drop-out voltage (at 20°C)	Over 5% of rated voltage	Over 5% of rated voltage	Over 5% of rated voltage
	Max. allowable voltage	130% or less of rated voltage	130% or less of rated voltage	110% or less of rated voltage
	Power consumption	0.2W(8.3mA)	0.2W(8.3mA)	0.36W(15mA)
Contact	Output device	Relay output	Relay output	SSR output
	Max. make/break voltage	250V AC, 110V DC	250V AC	100-240V AC
	Operating time(ms)	2-5	2-5(SZ-CD5: 3-6)	1 or less

■ Dimensions, mm

SZ-CD1,03/CD2-24 (Top mount)

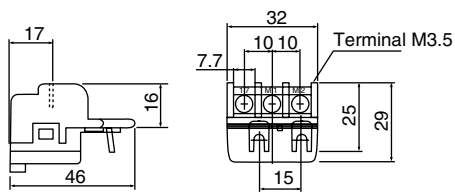

Mass: 26g

SZ-CD3,CD4 (Top mount)

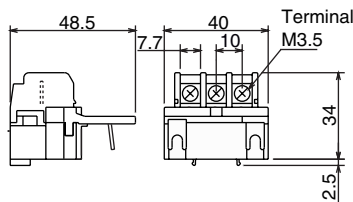

Mass: 28g

SZ-CD5,CD6 (Side mount)

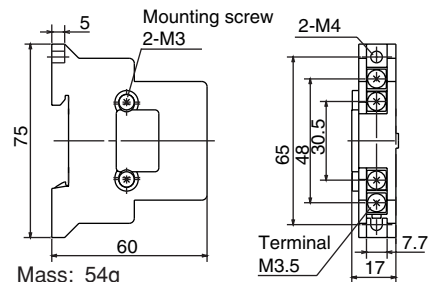

Mass: 54g

■ Wiring diagrams

SZ-CD1

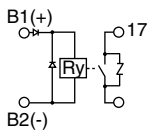

SZ-03/CD2-24

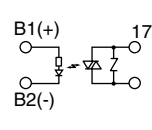

SZ-CD3

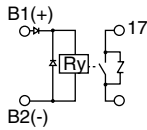

SZ-CD4

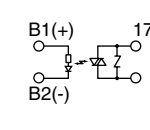

SZ-CD5

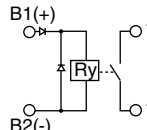

SZ-CD6

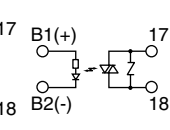

Magnetic Contactors and Starters

SC and SW series

Optional unit

Coil surge suppression units SZ-Z

■ Description

This unit suppresses coil surge voltage due to contactor ON-OFF operations. This unit can be easily connected to contactor coil terminals.

Varistor types cut the peak value of surge voltages and CR types suppress rapid increases of surge voltage.

Standard type contactors SC-N5 to N16 are provided with surge suppression devices.

Coil surge suppression unit (for SC-03 to 5-1, SC-N1 to N4)

Type	Device	Coil voltage	Used with
SZ-Z1	Varistor	24–48V AC/DC	SC-03 to 5-1
SZ-Z2	Varistor	100–250V AC/DC	
SZ-Z3	Varistor	380–440V AC	
SZ-Z4	CR	24–48V AC/DC	SC-03/G to 5-1/G
SZ-Z5	CR	100–250V AC/DC	
SZ-Z6 *	Varistor	24–48V AC/DC	
SZ-Z7 *	Varistor	100–250V AC/DC	
SZ-Z8 *	CR	24–48V AC/DC	SC-N1 to N3
SZ-Z9 *	CR	100–250V AC/DC	
SZ-Z31	Varistor	24–48V AC/DC	SC-N1/G to N3/G
SZ-Z32	Varistor	100–250V AC/DC	
SZ-Z33	Varistor	380–440V AC	
SZ-Z34	CR	24–48V AC	SC-N1 to N3
SZ-Z35	CR	100–250V AC	
SZ-Z36	CR	24–48V DC	SC-N1/G to N3/G
SZ-Z37	CR	100–250V DC	
SZ-Z41	Varistor	24–48V AC	SC-N4
SZ-Z42	Varistor	100–250V AC	
SZ-Z43	Varistor	380–440V AC	
SZ-Z44	CR	24–48V AC	
SZ-Z45	CR	100–250V AC	

Note: * With LED operating indicator



■ Dimensions, mm

SZ-Z1 to Z5 SZ-Z24, Z25

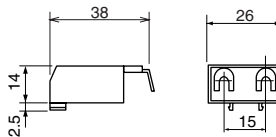

Mass: 14g

SZ-Z6 to Z9

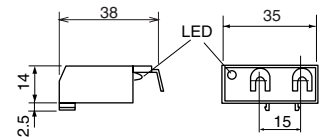

Mass: 16g

SZ-Z31 to Z37

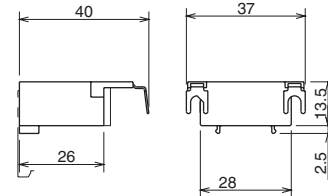

Mass: 15g

SZ-Z41 to Z45

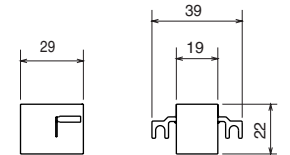

Mass: 15g

■ Characteristics (coil rated 200V AC)

● Without coil surge suppression unit

When current through a coil is interrupted, the sudden change of coil current, induces an abrupt surge voltage due to the coil inductance. The surge voltage sometimes produces noise which can damage or cause adjacent electronic devices to malfunction.

SC-0 (0.1msec/div, 1000V/div)
200V AC coil

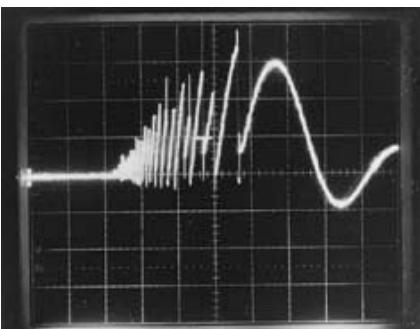

CP-487

● With coil surge suppression unit Varistor type

A surge voltage that exceeds a certain value causes a current to flow through the varistor connected in parallel with the coil, thereby suppressing peaks of the surge voltage. This surge suppression unit can be used in both AC and DC circuits.

SC-0+SZ-Z2 (2msec/div, 200V/div)
200V AC coil

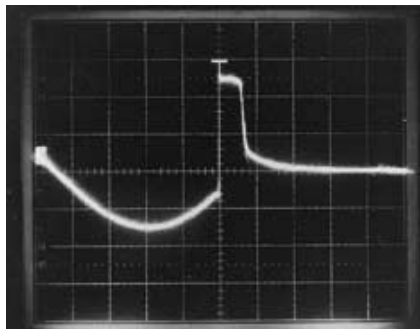

CP-489

● With coil surge suppression unit CR type

A CR (Capacitor-resistor) circuit connected in parallel with the coil suppresses the abrupt increase of surge voltage (dv/dt characteristics) by lowering the surge voltage oscillation frequency.

This surge suppression unit can be used in both AC and DC circuits.

SC-0+SZ-Z5 (2msec/div, 200V/div)
200V AC coil

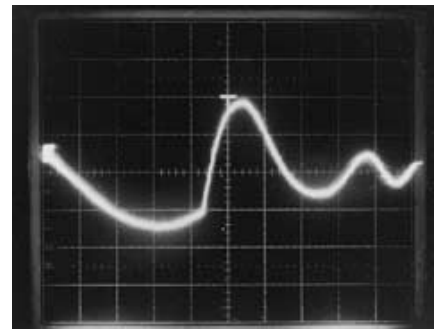

CP-488

Main circuit surge suppression units SZ-ZM

■ **Description**

This unit consists of delta connected capacitor (C) and resistor (R).
 When contactor is energized or de-energized, a surge voltage is generated from motor circuit. This unit suppresses this surge voltage and protects electronic equipment from malfunction or damage.
 Space saving, front mounting type (SZ-ZM1) and side mounting type (SZ-ZM2), which allows simultaneous use of other front mounting optional unit.

Type	Mounting	Voltage	CR constant	Used with
SZ-ZM1	Front	250V AC	C=0.22μF R=100Ω	SC-03 to SC-5-1
SZ-ZM2	Side	50/60Hz	C=0.33μF R=47Ω	SC-N1 to SC-N3

Note: SZ-ZM1 is not applicable to SC-5-1 with auxiliary contact 2NO+2NC.

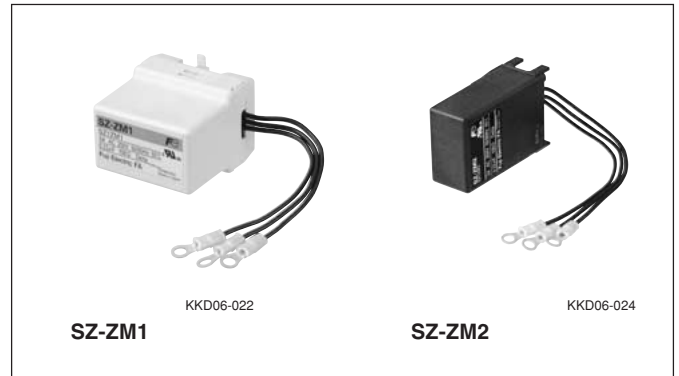

■ **Performance**

Dielectric strength: 230% × Rated voltage, 1min. between terminals
 2 × Rated voltage + 1,000V, between terminals and case
 Insulation resistance: 2,000MΩ or more
 Capacitance tolerance: ±10% or less at 1kHz

■ **Characteristics**

- **(200V AC 2.2kW motor)**
- **With surge suppression unit** (5μsec/div 200V/div)

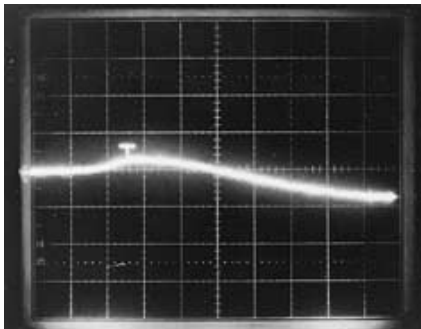

CP-486

- **Without surge suppression unit** (5μsec/div 200V/div)

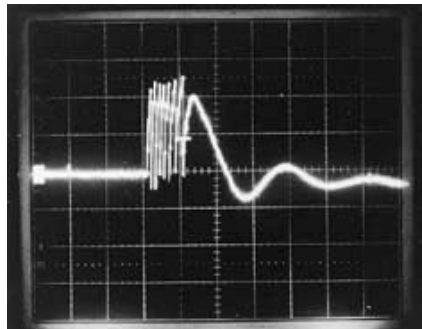

CP-485

■ **Wiring example**

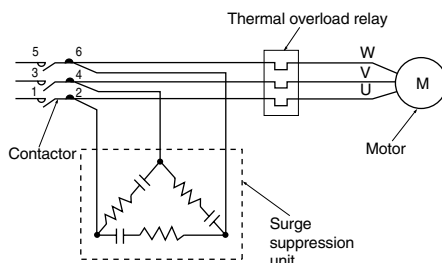

■ **Dimensions, mm**
SZ-ZM1, ZM3

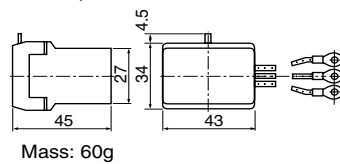

SZ-ZM2, ZM4

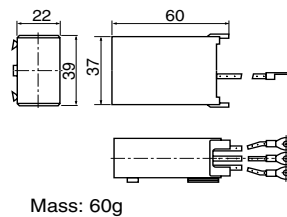

■ **Mounting methods**

- **Front mounting/SZ-ZM1, ZM3**
 Set the unit on the contactor and slide it in direction ②.
 Make sure that the unit's hook is in the mounting slot.
 To detach the unit, push up on the unit's hook and move the unit in the reverse of direction ②.
 Connect the 3 lead wires of the unit to the contactor's load side terminals 2, 4 and 6. Wires can be connected to any of the terminals 2, 4 or 6.

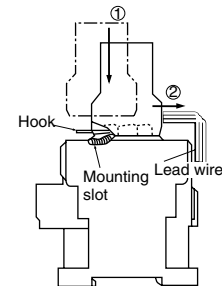

- **Side mounting /SZ-ZM2, ZM4**
 Push the protruding portions of the unit into the mounting slots of the contactor. Connect the 3 lead wires of the unit to the contactor's load side terminals 2, 4 and 6. Wires can be connected to any of the terminals 2,4 or 6.

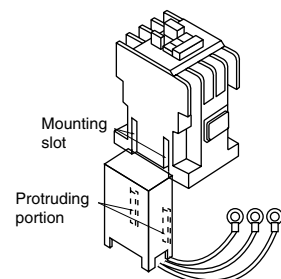

Magnetic Contactors and Starters

SC and SW series

Optional unit

Mechanical interlock units and power connection kit for reversing

This SZ-RM unit consists of an interlock block, which mechanically prevents the simultaneous engagement of forward and reverse contactors, and a connector block. A reversing contactor can be easily assembled with this unit at site.

An interlock mechanism prevents the engagement of 2 contactors at the same time.

Interlock unit		Power connection kit for reversing		
Type	Used with	Type	Color	Used with
SZ-RM	SC-03 to N3	SZ-RW1	Blue	SC-03, SC-0
		SZ-RW2	Black	SC-05
		SZ-RW3	Yellow	SC-4-0, SC-4-1
		SZ-RW4	White	SC-5-1
		SZ-RW5	White	SC-N1, SC-N2
		SZ-RW6	White	SC-N2S, SC-N3

■ Mounting methods

- Position an interlock block between two contactors so that the tall, square projections ① on the movable portions on either side of the interlock block fit into the square holes ② on the sides of the contactors. The short, round projections ③ on the sides of the interlock block should fit into the round holes ④ on the sides of the contactors.
- Insert the guides ⑤ on the ends of the connector block into the slots ⑥ in the sides of the contactors and push the connector block in between the contactors until the frames ⑦ of the projecting windows on the ends of the connector block catch firmly on the hook-like projections ⑧ on the interlock block.
- After connecting the contactors to each other, make sure that they operate smoothly by pressing down the movable manual operator one at a time.
- To separate the contactors, insert the end of a flat-bladed screwdriver under the frame ⑦ of one of the projecting windows on the connector block and lift it up and over the hook-like projection ⑧ on the interlock block. While lifting up on the frame ⑦, push against the connector block to eject it from between the contactors.

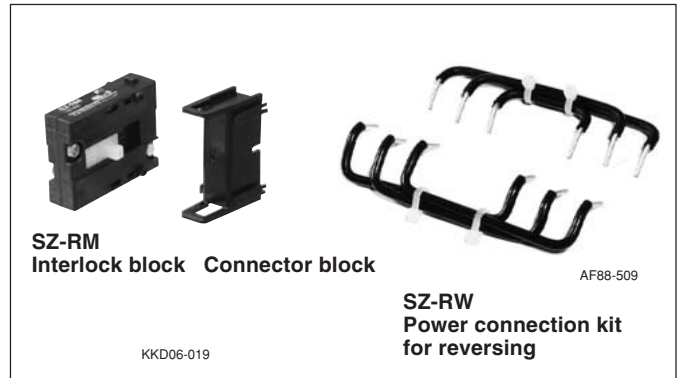
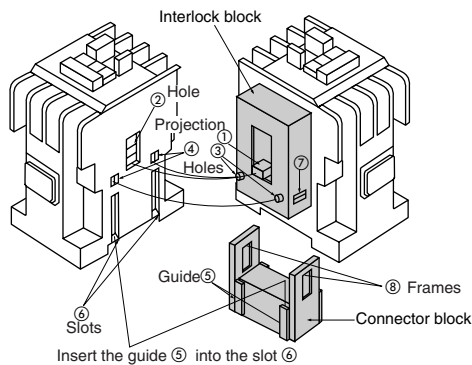

■ Dimensions, mm

Interlock block

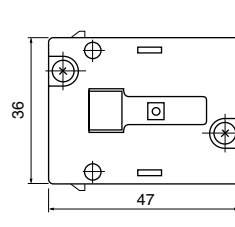

Mass: 18g

Connector block

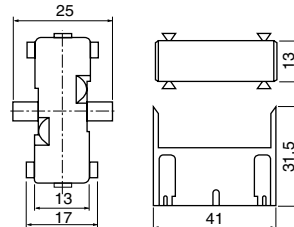

Mass: 4.2g

Power connection kit for reversing

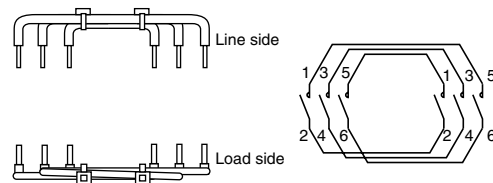

Cautions on attaching interlock unit to SC-03 and SC-0

Insert the protruded portion of the interlock unit into the upper (not lower) part of two slots on the side of the contactor by pressing the manual operator of the contactor.

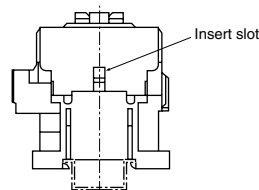

Operation counter units for SC-03 to N3

■ **Features**

This unit counts the ON-OFF operation times of a contactor. The contact lifetime can be estimated at a glance. This operation counter unit is a mechanical type counter which can be easily attached to the SC series contactors (Frame size 03 to N3) with snap-on fittings. Before, the operation times of contactors were estimated from the operation status of other equipment. However, the operation times of contactors can be precisely counted and easily checked with this unit.

The date for periodical maintenance and contact lifetime can be estimated directly counting the operation times of contactors. So preventive maintenance of important facilities or plant become more effective. 2 types (without and with output contact type) are available. The first one only counts and display the operation times up to 9,999,999. The another type is an output contact type which outputs the alarm output with a built-in reed switch after counting and displaying specified operation times (fixed).

■ **Specifications**

Type	SZ-J	SZ-J□
Alarm output contact	Not provided	Provided
Number of digits	7 digits	
Counting method	The counter increments by one each time the contactor completes one ON-OFF operation	
Counting speed	Max. 10Hz	
Reset function (to 0)	Not provided	
Output contact Arrangement	—	1NO
Rating	—	24V AC/DC 100mA
Making current	—	Max. 0.4A
Mechanical durability	10 million operations	
Used with	SC-03 to SC-N3	SC-03 to SC-5-1

■ **Types and output contact operation**

Type	Preset operation value	
	ON	OFF
SZ-J	—	—
SZ-J1	1 million	3 million
SZ-J2	2 million	4 million
SZ-J3	3 million	5 million
SZ-J4	4 million	6 million
SZ-J5	5 million	7 million
SZ-J6	6 million	8 million
SZ-J7	7 million	9 million
SZ-J8	8 million	0

■ **Wiring diagram (Example)**

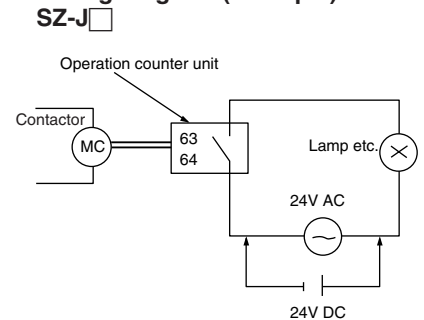

■ **Dimensions, mm**

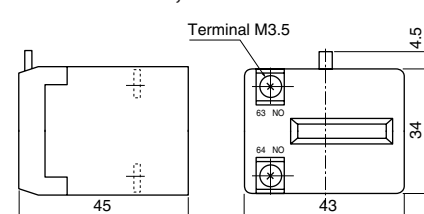

Mass: SZ-J 35g
 SZ-J1 to J8 39g



■ **Operation**

SZ-J Without output contact

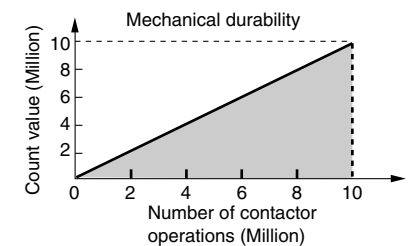

SZ-J□ With output contact Example SZ-J5

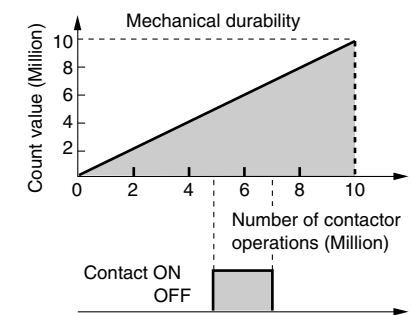

Note: The SZ-J□ operation counters (with alarm output contact) continue counting after an alarm is output. The alarm output is maintained for about 2 million operations.

Magnetic Contactors and Starters

SC and SW series

Optional unit

Terminal covers

The SZ-T type terminal cover conforms to DIN 57106 and VDE 0106 Teil 100 requirements regarding worker safety. The cover increases safety during maintenance and inspection.

Description	Type	Used with
For contactor	SZ-T1	SC-03, 0, SH-4
	SZ-T2	SC-05, SH5
	SZ-T3	SC-4-0, 4-1
	SZ-T4	SC-5-1, SJ-1SG
	SZ-T22	SC-N1, N2
	SZ-T23	SC-N2S, N3
	SZ-N4T	SC-N4, N5
	SZ-N6T	SC-N6
	SZ-N7T	SC-N7
	SZ-N8T	SC-N8, N10
	SZ-N11T	SC-N11, N12
For starter	SZ-T1	SW-03/3H, 0/3H
	SZ-T12	
	SZ-T2	SW-05/3H
	SZ-T12	
	SZ-T3	SW-4-0/3H, 4-1/3H
	SZ-T13	SJ-1SWG
	SZ-T4	SW-5-1/3H
	SZ-T13	
	SZ-T22	SW-N1/3H, N2/3H
	SZ-T16	
	SZ-T23	SW-N2S/3H, N3/3H
	SZ-T17	
	SZ-N4T	SW-N4/3H, N5/3H
	SZ-WN4T	
SZ-N6T	SW-N6/3H	
SZ-WN6T		
SZ-N7T	SW-N7/3H	
SZ-WN7T		
SZ-N8T	SW-N8/3H	
SZ-WN8T		
SZ-N8T	SW-N10/3H	
SZ-WN10T		
SZ-N11T	SW-N11/3H, N12/3H	
SZ-WN11T		
For auxiliary contact block	SZ-T5	SZ-A40, A31, A22, A222 SZ-A40H, A31H, A22H
	SZ-T6	SZ-A20, A11, A02, A111
	SZ-T7	SZ-AS1, AS2 SZ-AS1H, AS2H, AS3H
For thermal overload relay on-contactor mounting	SZ-T12	TR-0N, TK-0N
	SZ-T13	TR-5-1N, TK-5-1N
	SZ-T16	TR-N2, TK-N2
	SZ-T17	TR-N3, TK-N3
For thermal overload relay separate mounting	SZ-T14	TR-N2H, TK-N2H
	SZ-T15	TR-N3H, TK-N3H
	SZ-RN6T	TR-N6H, TK-N6H
Thermal overload relay base unit for separate mounting	SZ-T10	SZ-HB
	SZ-T11	SZ-HC
For coil drive unit	SZ-T7	SZ-CD5, SZ-CD6

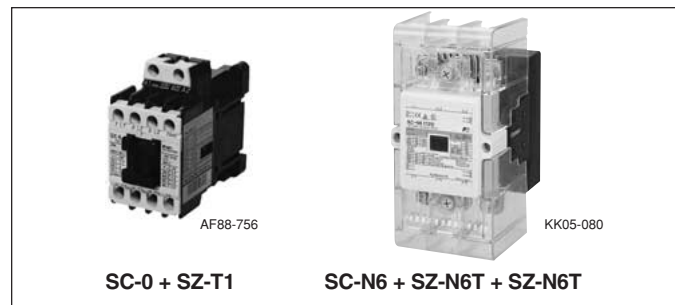

Description	Type	Used with
For reversing contactor	SZ-T1	SC-03RM, 0RM
	SZ-T2	SC-05RM
	SZ-T3	SC-4-0RM, 4-1RM
	SZ-T4	SC-5-1RM
	SZ-T22	SC-N1RM, N2RM
	SZ-T23	SC-N2SRM, N3RM
	SZ-N4RT1	SC-N4RM, N5RM
	SZ-N4RT2	
	SZ-N6RT1	SC-N6RM
	SZ-N6RT2	
	SZ-N7RT1	SC-N7RM
SZ-N7RT2		
SZ-N8RT1	SC-N8RM, N10RM	
SZ-N8RT2		
SZ-N11RT1	SC-N11RM, N12RM	
SZ-N11RT2		
For reversing starter	SZ-T1	SW-03RM, 0RM
	SZ-T12	
	SZ-T2	SW-05RM
	SZ-T12	
	SZ-T3	SW-4-0RM, 4-1RM
	SZ-T13	
	SZ-T4	SW-5-1RM
	SZ-T13	
	SZ-T22	SW-N1RM, N2RM
SZ-T16		
SZ-T23	SW-N2SRM, N3RM	
SZ-T17		

■ Contactors and starters with terminal cover

Contactors, starters, industrial relays, and thermal overload relays with a terminal cover are also available as the finger-protected type for the European market. Suffix the code /T at the end of the type number, when ordering, for this type.

Example

SC-03/T type: Contactor **SC-03**+Terminal cover **SZ-T1**

SW-03/3HT type: Starter **SW-03/3H**+Terminal cover

SZ-T1+SZ-T12

Terminal covers (Continued)

■ **Dimensions, mm**
Contactors

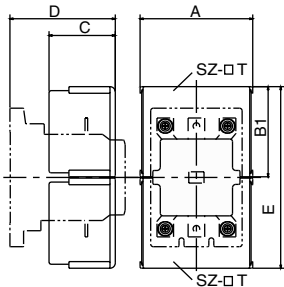

Fig.1

Starters

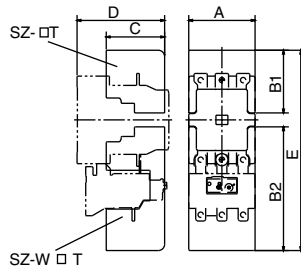

Fig.2

Reversing contactors

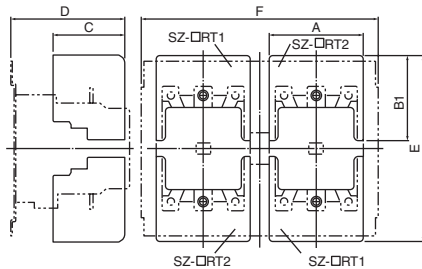

Fig.3

Type	Line side	Load side	A	B1	B2	C	D	E	F	Fig. No.
SZ-N4T	SZ-N4T	SZ-N4T	97.5	90	—	91.5	119*1	199	—	1
SZ-N6T	SZ-N6T	SZ-N6T	100	94.5	—	88	132	210	—	1
SZ-N7T	SZ-N7T	SZ-N7T	115	104	—	89	134	228	—	1
SZ-N8T	SZ-N8T	SZ-N8T	170	136	—	100	159	274	—	1
SZ-N11	SZ-N11T	SZ-N11T	185	175	—	116	175	352	—	1
SZ-N4T	SZ-WN4T	SZ-WN4T	97.5	90	143.5	91.5	119*1	252.5	—	2
SZ-N6T	SZ-WN6T	SZ-WN6T	100	94.5	186.5	88	132	302	—	2
SZ-N7T	SZ-WN7T	SZ-WN7T	115	104	193	89	134	317	—	2
SZ-N8T	SZ-WN8T	SZ-WN8T	170	136	237	100	159	375	—	2
SZ-N8T	SZ-WN10T	SZ-WN10T	170	136	228	100	159	366	—	2
SZ-N11T	SZ-WN11T	SZ-WN11T	185	175	304	116	175	481	—	2
SZ-N4RT1	SZ-N4RT2	SZ-N4RT2	97.5	90	—	91.5	124*2	199	230	3
SZ-N6RT1	SZ-N6RT2	SZ-N6RT2	100	94.5	—	88	140	210	250	3
SZ-N7RT1	SZ-N7RT2	SZ-N7RT2	115	104	—	89	144	228	290	3
SZ-N8RT1	SZ-N8RT2	SZ-N8RT2	160	136	—	100	172	277	330	3
SZ-N11RT1	SZ-N11RT2	SZ-N11RT2	175	175	—	116	194	352	360	3

Note: *1 134 for SC-N5, SW-N5 *2 139 for SC-N5RM

■ **Mounting methods**

SZ-N4T, SZ-WN4T

**SZ-N6T to N11T,
 SZ-WN6T to WN11T**

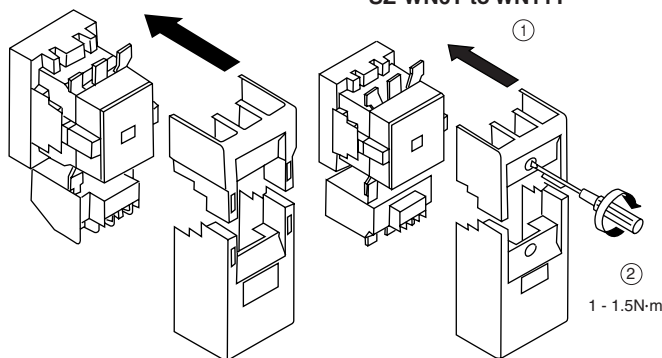

Insulation barriers for SC-N4 to N12

■ **Features**

These optional insulation barriers, prevent accidental short-circuits caused by metallic objects falling onto the terminals



SW-N6+SZ-B1

Description	Type	Used with
For contactor	SZ-B1	SC-N4, N5, N6, N7
	SZ-B2	SC-N8, N10, N11, N12
For starter	SZ-B1	SW-N4/3H, N5/3H, N6/3H, N7/3H
	SZ-B2	SW-N8/3H, N10/3H, N11/3H, N12/3H
For thermal overload relay	SZ-B1	TR-N6H, TK-N6H
	SZ-B2	TR-N10H, N12H, TK-N10H, N12H

■ **Dimensions, mm**

SZ-B1

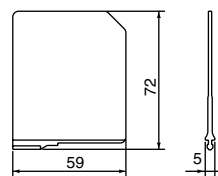

SZ-B2

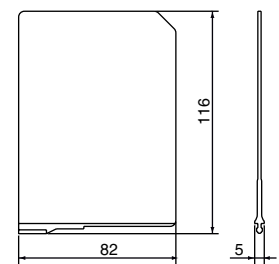

■ **Mounting methods**
Contactors

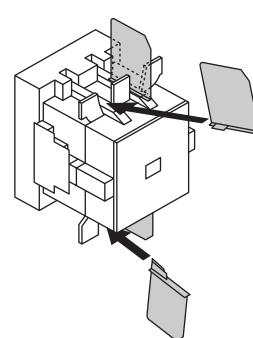

Starters

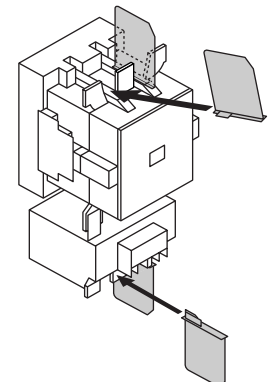

Thermal overload relays

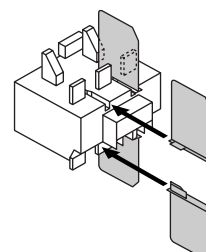

Magnetic Contactors and Starters

SC and SW series

Optional unit

Live-section cover

The live-section cover completely encloses the front of a contactor or starter for increased worker safety during maintenance and inspection.

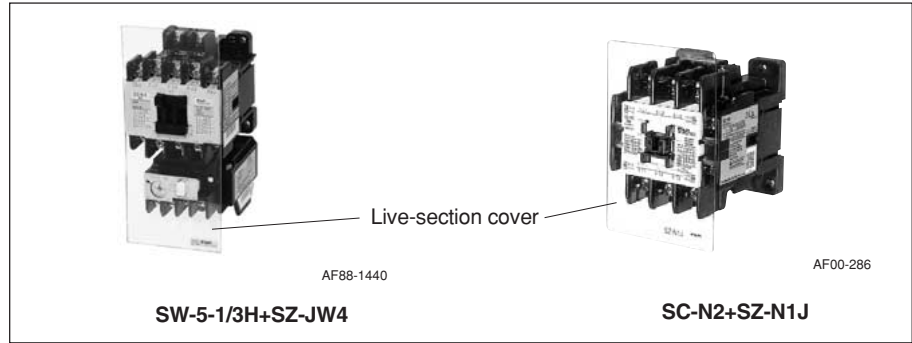

■ Dimensions, mm

- Contactors
- Starters

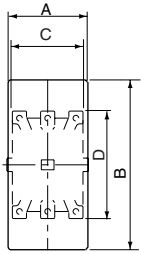

Fig. 1

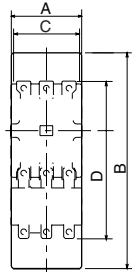

Fig. 2

- Starters (reversing)

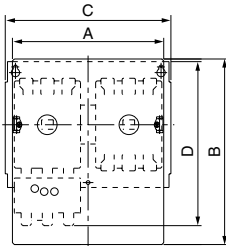
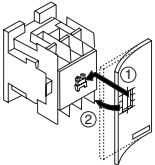

Fig. 3

■ Mounting methods

SZ-JC1 to JC4, SZ-N1J, N2SJ,
SZ-JW1 to JW4, SZ-WN1J, WN2SJ



SZ-N4J to N11J, SZ-WN4J to WN11J

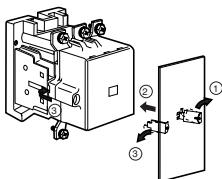

For contactor (Non-reversing)

Cover type	Contactor Type	Fig. No.	Live-section cover		Contactor	
			A	B	C	D
SZ-JC1	SC-03, 0	1	43	97	43	81
SZ-JC2	SC-05	1	53	97	53	81
SZ-JC3	SC-4-0, 4-1	1	53	100	53	81
SZ-JC4	SC-5-1	1	64	100	64	81
SZ-N1J	SC-N1, N2	1	74	120	74	87
SZ-N2SJ	SC-N2S, N3	1	88	140	88	110
SZ-N4J	SC-N4, N5	1	93	192	88	127
SZ-N6J	SC-N6	1	106	214	100	144
SZ-N7J	SC-N7	1	120	233	115	156
SZ-N8J	SC-N8, N10	1	138	265	138	209
SZ-N11J	SC-N11, N12	1	160	336	148	240

For starter (Non-reversing)

Cover type	Starter Type	Fig. No.	Live-section cover		Starter	
			A	B	C	D
SZ-JW1	SW-03/3H, 0/3H	2	44	140	44	122
SZ-JW2	SW-05/3H	2	53	140	53	122
SZ-JW3	SW-4-0/3H, 4-1/3H	2	53	145	53	127
SZ-JW4	SW-5-1/3H	2	64	145	64	127
SZ-WN1J	SW-N1/3H, N2/3H	2	74	175	74	146
SZ-WN2SJ	SW-N2S/3H, 3/3H	2	88	205	88	177
SZ-WN4J	SW-N4/3H, N5/3H	2	93	254	88	189
SZ-WN6J	SW-N6/3H	2	106	281	100	225
SZ-WN7J	SW-N7/3H	2	120	300	115	237
SZ-WN8J	SW-N8/3H	2	138	347	138	305
SZ-WN10J	SW-N10/3H	2	138	347	138	287
SZ-WN11J	SW-N11/3H, N12/3H	2	160	423	148	360

For starter (reversing)

Cover type	Starter Type	Fig. No.	Live-section cover		Starter	
			A	B	C	D
SZ-WN4RJ	SW-N4RM/3H, N5RM/3H	3	204	254	230	208
SZ-WN6RJ	SW-N6RM/3H	3	229	281	250	247.5
SZ-WN7RJ	SW-N7RM/3H	3	258	300	290	266
SZ-WN8RJ	SW-N8RM/3H	3	291	347	330	370
SZ-WN10RJ	SW-N10RM/3H	3	291	347	330	370
SZ-WN11RJ	SW-N11RM/3H, N12RM/3H	3	328	423	360	480

Note: Side mounting types with 4NO + 4NC auxiliary contacts are available. Add the suffix "/4" to the type number when ordering.