

Miniature control relays

■ **Description**

The HH52, 53 and 54 are a series of miniature general purpose relays specially designed for users demanding small size, sturdy construction and high electrical capacity. Mechanisms are furnished in polycarbonate dust-proof enclosures and are recommended for a multitude of electrical control applications for their reliability and compact size. Continuous duty coils, either AC or DC are available for voltages up to 240V AC or 120V DC. Contacts can be supplied in 2PDT, 3PDT, 4PDT arrangements. Continuous current ratings are 3, 5 and 7 Amps. Many terminal types are available for solder, plug-in or printed circuit board mounting.

■ **Features**

- 3, 5 and 7 Amp. contacts
- 2PDT, 3PDT and 4PDT
- Reliable operation, long service life
- High dielectric strength
- Solder, PC board, wire wrap and screw terminal socket
- AC or DC coils
- Barrired contacts for opposite polarity available
- Dust proof enclosures
- Approved by UL, CSA and TÜV
 UL recognized File No:
 E42419, E90265 (Socket)
 CSA: LR 20479
 TÜV:
 License No. R9251339 (HH52)
 R9251340 (HH53)
 R9251341 (HH54)
 T9251612 (TP58, 511, 514)
 T9251425 (RZ, FX)

■ **General information**

● **Contacts**

Miniature relays can be supplied with contacts that meet most electrical and mechanical contact requirements. The standard HH52, 53 and 54 series are of the single contact type as illustrated. The HH52W (2PDT) and HH54W (4PDT) relays are supplied with bifurcated contacts. These bifurcated contacts are with good conducting characteristics and are recommended where limited control power is available. The dielectric strength is 1000 volts rms 50/60Hz (between open contacts) which makes them more than adequate for power circuit use.

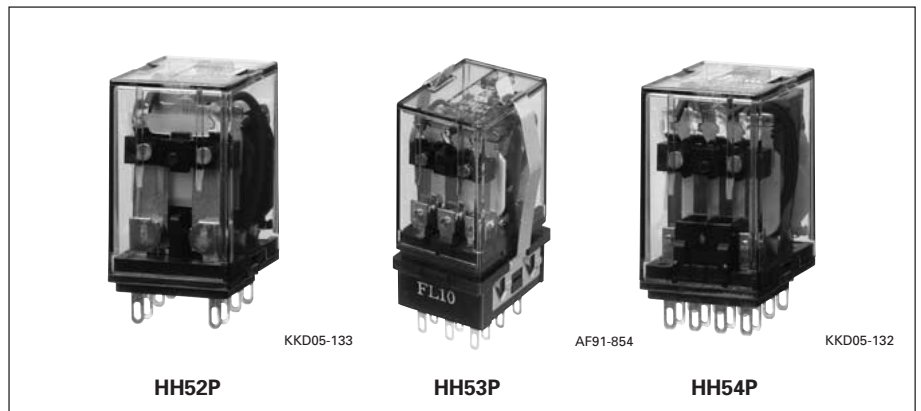

Contact arrangement are as follows:

Type	Contact arrangement	Rated thermal current
HH52U	2PDT	7 Amps
HH52, 52W	2PDT	5 Amps
HH53	3PDT	5 Amps
HH54U	4PDT	5 Amps
HH54, 54W	4PDT	3 Amps

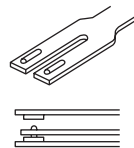

Bifurcated contact

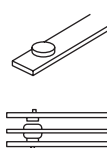

Single contact

● **Coils**

Coils are available with nominal voltages within the following ranges.

Coil voltage	Power consumption
6 to 120V DC	Approx. 0.9W
6 to 240V AC	Approx. 1.0VA
(50/60Hz)	(60Hz)

Special purpose relays can be supplied with diode for surge suppression, for operating display devices such as LED's, and magnetically held type.

● **Enclosures**

All miniature relays are enclosed in sturdy heat-resistant polycarbonate covers providing protection against dust and dirt.



Standard



Flange mounting

● **Terminals**

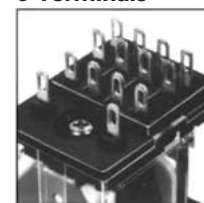

Plug-in type terminal

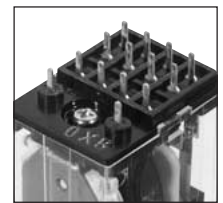

PC board type terminal

● **Sockets**

There is almost infinite choice of sockets. They can be adapted to all types of wiring including solder type, standard screw terminals, wire wrap and printed circuit. Sockets for rail mounting use are also available.

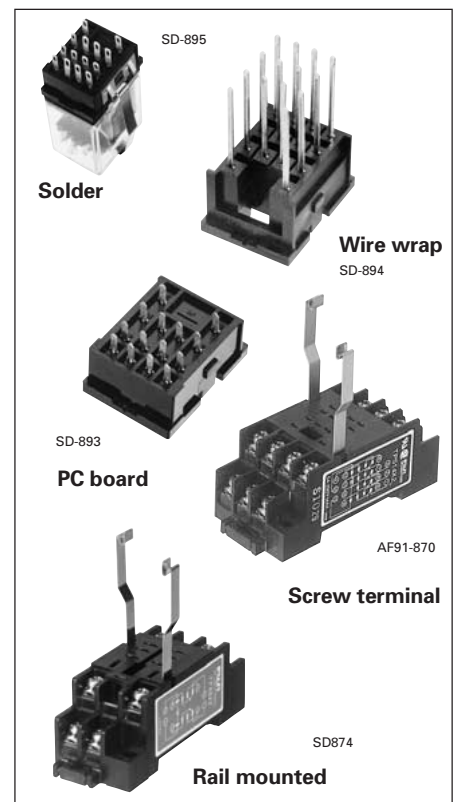

Industrial Control Relays

Miniature control relays

HH52, 53, 54

■ Versions

Operating status indicator

All relays can be supplied on request with a visual indicating signal—a light emitting diode (LED).

LED's are fitted to relays with nominal operating voltages up to 240 volts.

The LED emits highly visible red light for AC and green light for DC when power is applied to the relay coil, an extremely useful signal when trouble shooting either equipment or a system.

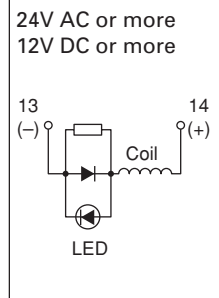
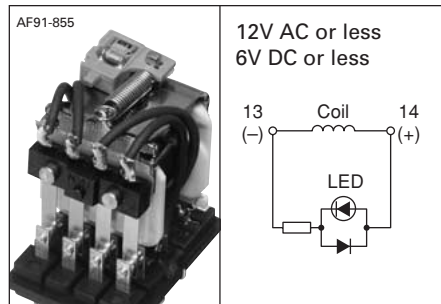

Surge suppression

We can also supply relays with a diode (or CR) for surge suppression. The highly efficient diode (or CR) is connected in parallel with the coil in order to suppress the surge generated within the coil. Consequently this coil can be used in electric circuits which include highly sensitive relays or transistors, etc. without interfering with their operation, so increasing the dependability of the equipment.

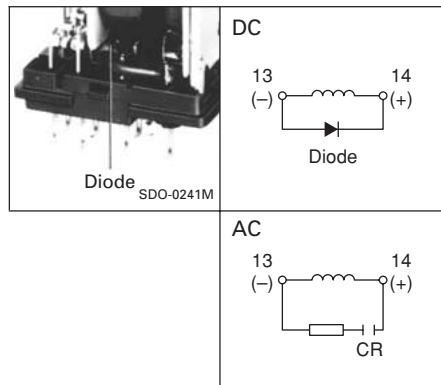

With operation indicator and surge suppression device

This type has a built-in operation indicator and surge suppressor.

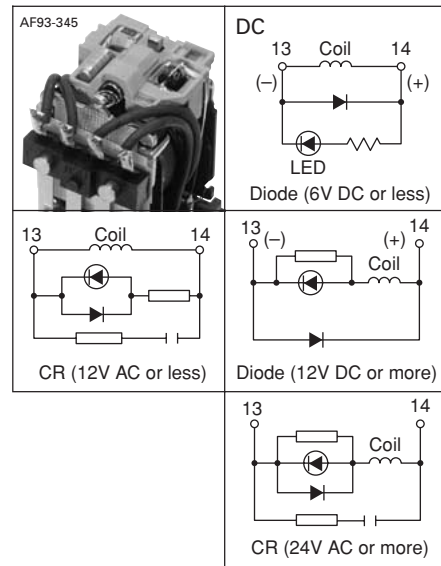

Dual coil magnetically held

One coil firmly holds the contacts in one position, the second coil releases them.

This relay has a good memory stability because it will maintain the ON condition during loss of power. It operates on a momentary pulse to either coil. The relay saves space as well as power, since a single unit occupies half the space of a mechanically interlocking latching relay of the same rating.

Voltages: 6V–110V AC, 6V–48V DC

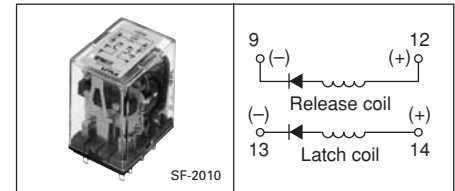

With extra pick-up operating coil

This type is recommended for use in poor power supply environments. Pick-up voltage: 65% of rated voltage (at 20°C)

Drop-out voltage: 10% of rated voltage (at 20°C)

Mechanical durability: 10 million operations

Other specifications are the same as those of the basic model.

High capacity type

This type is suitable for switching a load like solenoid. The current rating of the contacts is 7A for HH52PU and 5A for HH54PU. Other specifications are the same as those of the basic model.

With Au-plated Ag contact

Type HH □-J has gold-plated contacts. (Note: Models with bifurcated contacts and 4PDT high-capacity models are provided with gold-plated contacts as standard, even if their type number has no J.)

■ **Ordering code system**

● **Relay**

R M 2C P W R F-AH

① ② ③④ ⑤ ⑥ ⑦ ⑧ ⑨⑩

① **Product category**

Code	Description
R	Control relay

② **Series category**

Code	Description
M	Miniature control relay (HH52 to HH54)
P	Miniature power relay (HH62 to HH64)
C	General purpose relay (HH22 to HH24)

③④ **Contact arrangement**

Code	Contact arrangement
2 C	2PDT
3 C	3PDT
4 C	4PDT
3 M	1NO+1NC+SPDT
4 M	2NO+1NC+SPDT
4 2	2PDT with extra pick-up coil

⑤ **Mounting**

Code	Mounting
P	Plug-in mounting
B	PC board mounting
S	Flange mounting

⑥ **Contact form**

Code	Form
Blank	Single
W	Bifurcated
U	High capacity (HH52, 54)
J	Single (Au-plated)

⑦ **Version**

Code	Description
Blank	Standard
R	Magnetically held

⑧ **Accessory**

Code	Description
Blank	Not provided
F	With surge suppression diode (DC)
G	With LED indicator and surge suppression diode (DC)
L	With LED indicator
C	With surge suppression (CR)
A	With LED indicator and surge suppression CR (AC)

⑨⑩ **Operating coil**

Code	Coil voltage
A A	6V AC 50/60Hz
A B	12V AC 50/60Hz
A E	24V AC 50/60Hz
A F	48V AC 50/60Hz
A 1	100–110V AC 50/60Hz
A H	110–120V AC 50/60Hz
A 2	200–220V AC 50/60Hz
A M	220–240V AC 50/60Hz
D A	6V DC
D B	12V DC
D E	24V DC
D F	48V DC
D 1	100–110V DC

● **Socket**

R X 58 X2-CR ZT

① ② ③④ ⑤⑥ ⑦⑧ ⑨⑩

① **Product category**

Code	Description
R	Control relay

② **Series category**

Code	Description
X	Socket

③④ **Application**

Code	Type
5 8	TP58 (For HH52P)
5 1	TP511 (For HH53P)
5 4	TP514 (For HH54P)
6 8	TP68 (For HH62P)
6 1	TP611 (For HH63P)
6 4	TP614 (For HH64P)
8 G	8GB (For HH22P)
3 8	TP38 (For HH22P)
1 G	11GB (For HH23P)
3 1	TP311 (For HH23P)

⑤⑥ **Mounting and wiring**

Code	Description
Blank	Soldering
B 1	PC board
R 2	Wire wrap
	Surface mounting screw terminal (M3.5)
S 0	For HH22, 23, 24 Rail mounting screw terminal (M3.5)
X 0	For HH22, 23, 24
X 2	For HH52, 53, 54, HH62, 63, 64 Rail mounting screw terminal (M3)
X 1	For HH52, 53, 54

⑦⑧ **Socket with surge suppression device**

Code	Description
C R	Provided with CR circuit
C 1	Provided with 100V Z-trap (diode)
C 2	Provided with 200V Z-trap (diode)

⑨⑩ **Approvals**

Code	Standards
Z U	UL
Z S	UL/CSA
Z T	TÜV
Z L	Lloyd

Industrial Control Relays

Miniature control relays

HH52, 53, 54

■ Versions Relay

Classification		Contact form and arrangement		Mounting Plug-in Type	Ordering code	PC board Type	Ordering code	Flange Type	Ordering code
Standard	Without LED	Single	2PDT	HH52P	RM2CP-■	HH52B	RM2CB-■	HH52S	RM2CS-■
			3PDT	HH53P	RM3CP-■	HH53B	RM3CB-■	HH53S	RM3CS-■
		Bifurcated	4PDT	HH54P	RM4CP-■	HH54B	RM4CB-■	HH54S	RM4CS-■
			2PDT	HH52PW	RM2CPW-■	HH52BW	RM2CBW-■	HH52SW	RM2CSW-■
	With LED	Single	2PDT	HH52P-L	RM2CPL-■	HH52B-L	RM2CBL-■		
			3PDT	HH53P-L	RM3CPL-■	HH53B-L	RM3CBL-■		
		Bifurcated	4PDT	HH54P-L	RM4CPL-■	HH54B-L	RM4CBL-■		
			2PDT	HH52PW-L	RM2CPWL-■	HH52BW-L	RM2CBWL-■		
	With surge suppression diode	Single	2PDT	HH52P-F	RM2CPF-■	HH52B-F	RM2CBF-■	HH52S-F	RM2CSF-■
			3PDT	HH53P-F	RM3CPF-■	HH53B-F	RM3CBF-■	HH53S-F	RM3CSF-■
		Bifurcated	4PDT	HH54P-F	RM4CPF-■	HH54B-F	RM4CBF-■	HH54S-F	RM4CSF-■
			2PDT	HH52PW-F	RM2CPWF-■	HH52BW-F	RM2CBWF-■	HH52SW-F	RM2CSWF-■
With surge suppression diode and LED	Single	2PDT	HH52P-FL	RM2CPG-■	HH52B-FL	RM2CBG-■			
		3PDT	HH53P-FL	RM3CPG-■	HH53B-FL	RM3CBG-■			
	Bifurcated	4PDT	HH54P-FL	RM4CPG-■	HH54B-FL	RM4CBG-■			
		2PDT	HH52PW-FL	RM2CPWG-■	HH52BW-FL	RM2CBWG-■			
With surge suppression CR	Single	2PDT	HH52P-CR	RM2CPC-■	HH52B-CR	RM2CBC-■	HH52S-CR	RM2CSC-■	
		3PDT	HH53P-CR	RM3CPC-■	HH53B-CR	RM3CBC-■	HH53S-CR	RM3CSC-■	
	Bifurcated	4PDT	HH54P-CR	RM4CPC-■	HH54B-CR	RM4CBC-■	HH54S-CR	RM4CSC-■	
		2PDT	HH52PW-CR	RM2CPWC-■	HH52BW-CR	RM2CBWC-■	HH52SW-CR	RM2CSWC-■	
With surge suppression CR and LED	Single	2PDT	HH52P-CRL	RM2CPA-■	HH52B-CRL	RM2CBA-■			
		3PDT	HH53P-CRL	RM3CPA-■	HH53B-CRL	RM3CBA-■			
	Bifurcated	4PDT	HH54P-CRL	RM4CPA-■	HH54B-CRL	RM4CBA-■			
		2PDT	HH52PW-CRL	RM2CPWA-■	HH52BW-CRL	RM2CBWA-■			
Magnetically held	Single	2PDT	HH52P-R	RM2CPR-■	HH52B-R	RM2CBR-■	HH52S-R	RM2CSR-■	
	Bifurcated	2PDT	HH52PW-R	RM2CPWR-■	HH52BW-R	RM2CBWR-■	HH52SW-R	RM2CSWR-■	
High capacity	Without LED	Single	2PDT	HH52PU	RM2CPU-■	HH52BU	RM2CBU-■	HH52SU	RM2CSU-■
			4PDT	HH54PU	RM4CPU-■	HH54BU	RM4CBU-■	HH54SU	RM4CSU-■
	With LED	Single	2PDT	HH52PU-L	RM2CPUL-■	HH52BU-L	RM2CBUL-■		
			4PDT	HH54PU-L	RM4CPUL-■	HH54BU-L	RM4CBUL-■		
	With surge suppression diode	Single	2PDT	HH52PU-F	RM2CPUF-■	HH52BU-F	RM2CBUF-■	HH52SU-F	RM2CSUF-■
			4PDT	HH54PU-F	RM4CPUF-■	HH54BU-F	RM4CBUF-■	HH54SU-F	RM4CSUF-■
	With surge suppression diode and LED	Single	2PDT	HH52PU-FL	RM2CPUG-■	HH52BU-FL	RM2CBUG-■		
			4PDT	HH54PU-FL	RM4CPUG-■	HH54BU-FL	RM4CBUG-■		
	With surge suppression CR	Single	2PDT	HH52PU-CR	RM2CPUC-■	HH52BU-CR	RM2CBUC-■	HH52SU-CR	RM2CSUC-■
			4PDT	HH54PU-CR	RM4CPUC-■	HH54BU-CR	RM4CBUC-■	HH54SU-CR	RM4CSUC-■
With surge suppression CR and LED	Single	2PDT	HH52PU-CRL	RM2CPUA-■	HH52BU-CRL	RM2CBUA-■			
		4PDT	HH54PU-CRL	RM4CPUA-■	HH54BU-CRL	RM4CBUA-■			

- Notes: 1. UL, CSA, and TÜV approved.
2. Bifurcated contacts are all gold-plated silver contacts.
3. Enter the coil voltage code in the ■ mark.
4. For types with single contact other than high-capacity types, types with gold-plated silver contact are available on request. To order these types, add J to the ordering code. Refer to the ordering code system.
Example: RM2CPJ-■ (with gold-plated silver contact)
RM2CP-■ (with silver contact: standard)

Classification		Contact form and arrangement	Mounting Plug-in Type	Ordering code	PC board Type	Ordering code	Flange Type	Ordering code
With extra pick-up coil	Without LED	Single 2PDT	HH54-2P	RM42P-■	HH54-2B	RM42B-■	HH54-2S	RM42S-■
		Bifurcated 2PDT	HH54-2PW	RM42PW-■	HH54-2BW	RM42BW-■	HH54-2SW	RM42SW-■
		Single 2PDT	HH54-2P-L	RM42PL-■	HH54-2B-L	RM42BL-■		
	With LED	Bifurcated 2PDT	HH54-2PW-L	RM42PWL-■	HH54-2BW-L	RM42BWL-■		
		Single 2PDT	HH54-2P-F	RM42PF-■	HH54-2B-F	RM42BF-■	HH54-2S-F	RM42SF-■
		Bifurcated 2PDT	HH54-2PW-F	RM42PWF-■	HH54-2BW-F	RM42BWF-■	HH54-2SW-F	RM42SWF-■
	With surge suppression diode	Single 2PDT	HH54-2P-FL	RM42PG-■	HH54-2B-FL	RM42BG-■		
		Bifurcated 2PDT	HH54-2PW-FL	RM42PWG-■	HH54-2BW-FL	RM42BWG-■		
	With surge suppression CR	Single 2PDT	HH54-2P-CR	RM42PC-■	HH54-2B-CR	RM42BC-■	HH54-2S-CR	RM42SC-■
		Bifurcated 2PDT	HH54-2PW-CR	RM42PWC-■	HH54-2BW-CR	RM42BWC-■	HH54-2SW-CR	RM42SWC-■
	With surge suppression CR and LED	Single 2PDT	HH54-2P-CRL	RM42PA-■	HH54-2B-CRL	RM42BA-■		
		Bifurcated 2PDT	HH54-2PW-CRL	RM42PWA-■	HH54-2BW-CRL	RM42BWA-■		

- Notes:
- Bifurcated contacts are all gold-plated silver contacts.
 - Enter the coil voltage code in the ■ mark.
 - For types with single contact other than high-capacity types, types with gold-plated silver contact are available on request. To order these types, add J to the ordering code. Refer to the ordering code system.
- Example: RM2CPJ-■ (with gold-plated silver contact)
 RM2CP-■ (with silver contact: standard)

Industrial Control Relays

Miniature control relays

HH52, 53, 54

■ Sockets

Description	Standard *			With surge suppression device				Mass (g)	Used with		
	Type	Ordering code	Mass (g)	CR circuit Type	Ordering code	100V Z-trap Type	Ordering code			200V Z-trap Type	Ordering code
Soldering	TP58	RX58	9	-	-	-	-	-	-	HH52P	
	TP511	RX51	10	-	-	-	-	-	-	HH53P	
	TP514	RX54	10	-	-	-	-	-	-	HH54P	
PC board	TP58B	RX58B1	9	-	-	-	-	-	-	HH52P	
	TP511B	RX51B1	9.5	-	-	-	-	-	-	HH53P	
	TP514B	RX54B1	9.5	-	-	-	-	-	-	HH54P	
Wire wrap	TP58R2	RX58R2	10.5	-	-	-	-	-	-	HH52P	
	TP511R2	RX51R2	11.5	-	-	-	-	-	-	HH53P	
	TP514R2	RX54R2	12.5	-	-	-	-	-	-	HH54P	
Rail mounting screw terminal M3.5	TP58X2	RX58X2	49	TP58X2-CR	RX58X2-CR	TP58X2-Z/100	RX58X2-C1	TP58X2-Z/200	RX58X2-C2	49	HH52P
	TP511X2	RX51X2	50	TP511X2-CR	RX51X2-CR	TP511X2-Z/100	RX51X2-C1	TP511X2-Z/200	RX51X2-C2	50	HH53P
	TP514X2	RX54X2	62	TP514X2-CR	RX54X2-CR	TP514X2-Z/100	RX54X2-C1	TP514X2-Z/200	RX54X2-C2	62	HH54P
Rail mounting screw terminal M3.0	TP58X1	RX58X1	32	TP58X1-CR	RX58X1-CR	-	-	-	-	32	HH52P
	-	-	-	-	-	-	-	-	-	-	-
	TP514X1	RX54X1	49	TP514X1-CR	RX54X1-CR	-	-	-	-	49	HH54P

Note: *UL, CSA and TÜV approved

■ Mounting plates and rails

Type	Ordering code	Socket capacity* (Max.)
TX01	RZ01	1 pc.
TX16	RZ16	16 pcs.
TX19	RZ19	19 pcs.
TX18C	RZ18C	18 pcs.
TX36C1	RZ36C1	36 pcs.

Mounting plate

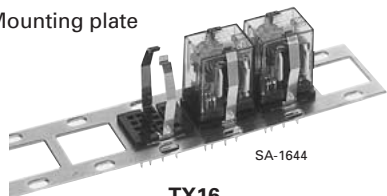

TX16

Mounting rail 900mm

TH35-7.5	RR7F
TH35-7.5AL	RR7A
TH35-15AL	RR15A

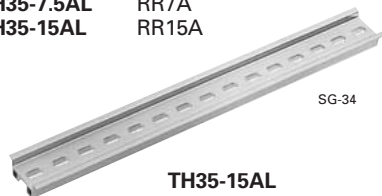

TH35-15AL

Minimum ordering quantity: 10 pcs. (1 pack)

Notes: Plates will accept both soldering terminal and wire wrap terminal sockets.

* No. of relays to be mounted directly.

■ Type number nomenclature Relays

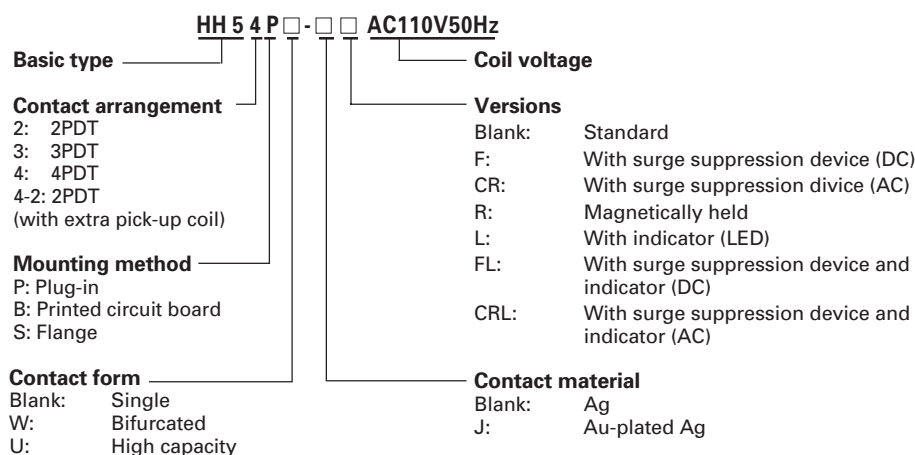

Sockets

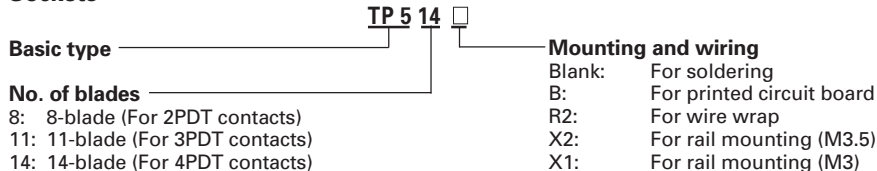

■ Ordering information

Specify the following:

1. Ordering code or type number
2. Coil voltage
3. Socket type number

■ Specifications

Basic type		HH52 HH53	HH54	HH52U	HH54U	HH52W	HH54W
Contact form	Single					Bifurcated	
Rated thermal current (A)		5	3	7	5	5	3
Rated insulation voltage	250V						
Pick-up voltage (at 20° C)	AC	80% of rated voltage					
	DC	75% of rated voltage					
Drop-out voltage (at 20° C)	AC	30% of rated voltage					
	DC	10% of rated voltage					
Max. power supply voltage	110% of rated voltage						
Operating temperature	-55 to +70°C, no icing (-25 to +60°C for with operating indicator)						
Dielectric strength	2000V AC rms, 1 minute between coil and contact 2000V AC rms, 1 minute between poles 1000V AC rms, 1 minute between open contacts 2000V AC rms, 1 minute between socket terminals						
Insulation resistance	100MΩ (500V DC megger)						
Operating time	20ms or less						
Vibration	Mechanical and malfunction durability: 10 to 55Hz, 1mm double amplitude						
Shock	Malfunction durability: 200m/s ² Mechanical durability: 1000m/s ²						
Durability	Mechanical	AC ratings: 50 million operations					
		DC ratings: 100 million operations					
Contact resistance (before use)	50mΩ max.						
Mass	Approx. 33g						

Notes: HH52PW, 54PW, HH54PU: Au-plated Ag contact as standard
 HH52P, 53P, 54P: Ag contact as standard

■ Coil characteristics

- AC coil

Order voltage code	Rated voltage (V)	Rated current (mA)		Coil resistance (Ω)	Coil color	Power consumption (VA)	
		50Hz	60Hz			50Hz	60Hz
AC6	6	200	167	10	Clear	1.2	1.0
AC12	12	100	83	46	Clear		
AC24	24	50	42	187	Clear		
AC48	48	25	21	746	Clear		
AC100	100/110	12/12.7	10/10.9	3680	Green	1.2/1.4	1.0/1.2
AC110	110/120	10.9/11.7	9.1/10	4320	Clear		
AC200	200/220	6/6.4	5/5.5	13400	Yellow		
AC220	220/240	5.5/5.8	4.5/5	17200	Clear		

Note: Other voltages up to 240V AC are also available, contact FUJI.

- DC coil

Order voltage code	Voltage (V)	Rated current (mA)	Coil resistance (Ω)	Coil color	Power consumption (W)
DC6	6	150	40	Clear	0.9
DC12	12	75	160	Black	
DC24	24	37	650	Grape	
DC48	48	18.5	2600	Red	
DC100	100/110	9.1/10	11000	Blue	

Note: Other voltages up to 130V DC are also available on request, contact FUJI.

Industrial Control Relays

Miniature control relays

HH52, 53, 54

■ Operating current and electrical durability

Voltage	Make Current (A)	Power factor or time constant	Break Current (A)	Power factor or time constant	Electrical life ($\times 10^3$ operations)				
					HH52U	HH52, HH53	HH54 HH54U	HH52W	HH54W
200V AC Ind. load	10	$\text{Cos}\phi = 0.7$	1	$\text{Cos}\phi = 0.3$ to 0.4	1000	400	80	150	–
	5		0.5		2000	1000	200	400	–
	3		0.3		3500	1700	330	660	80
100V AC Ind. load	10	$\text{Cos}\phi = 0.7$	1	$\text{Cos}\phi = 0.3$ to 0.4	1500	700	130	260	–
	5		0.5		3300	1500	280	560	70
	3		0.3		6000	2800	500	1000	120
200V AC Res. load	3	$\text{Cos}\phi = 1$	3	$\text{Cos}\phi = 1$	1200	600	150	300	–
	1		1		4000	2000	500	1000	130
100V AC Res. load	3	$\text{Cos}\phi = 1$	3	$\text{Cos}\phi = 1$	1700	1000	250	500	60
	1		1		6000	3400	900	1800	120
24V DC Ind. load	1	T=15msec.	1	T=15msec.	1000	500	150	300	–
	0.2		0.2		8400	4000	1200	2400	400
24V DC Res. load	3	T=0msec.	3	T=0msec.	1000	400	100	200	–
	1		1		4500	1600	400	800	100

■ Ratings (UL and CSA)

Basic type	Voltage	Single-phase* motor (HP)	Resistive load (A)	Inductive load (A)	Remarks (polarity)
HH52P, 52B 52S HH53P, 53B 53S	120V AC	1/6	5	1.5	Same polarity between adjacent contacts for inductive load Opposite polarity for others
	240V AC	1/4	5	–	
	30V DC	–	5	2(15ms)	
	120V DC	–	0.3	0.2(15ms)	
HH54P, 54B, 54S	120V AC	1/10	3	1	Same polarity between adjacent contacts for inductive load Opposite polarity for others
	240V AC	1/4	3	–	
	30V DC	–	3	2(15ms)	
	120V DC	–	0.3	0.2(15ms)	
HH52PU, 52BU, 52SU	120V AC	1/4	7	1.5	Same polarity between adjacent contacts for inductive load Opposite polarity for others
	240V AC	3/4	7	–	
	30V DC	–	7	2(15ms)	
	120V DC	–	0.3	0.2(15ms)	
HH54PU, 54BU, 54SU	120V AC	1/8	5	1	Same polarity between adjacent contacts for inductive load Opposite polarity for others
	240V AC	1/4	5	–	
	30V DC	–	5	2(15ms)	
	120V DC	–	0.3	0.2(15ms)	
HH52PW, 52BW, 52SW	120V AC	1/6	5	1.5	Same polarity between adjacent contacts for inductive load Opposite polarity for others
	240V AC	1/4	5	–	
	30V DC	–	5	2(15ms)	
	120V DC	–	0.3	0.2(15ms)	
HH54PW, 54BW, 54SW	120V AC	–	3	1	Same polarity between adjacent contacts for inductive load Opposite polarity for others
	240V AC	–	3	–	
	30V DC	–	3	2(15ms)	
	120V DC	–	0.2	0.2(15ms)	

Note: *UL and CSA approvals only.

■ Dimensions, mm/Relays
Plug-in

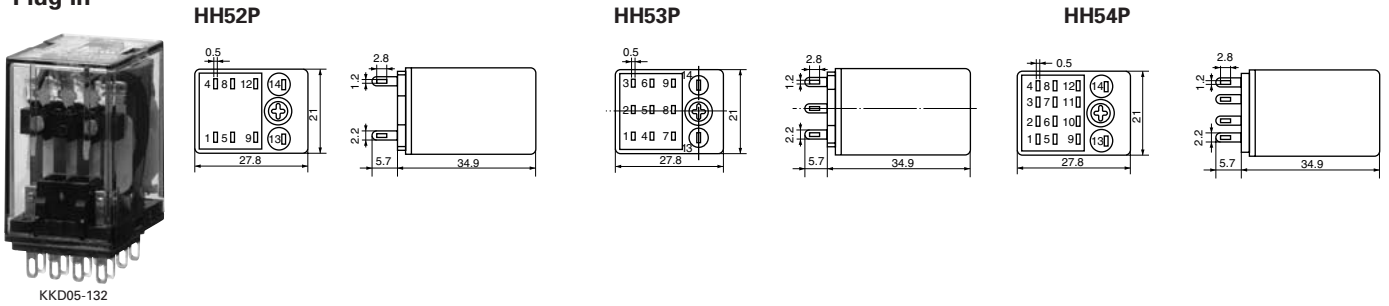

P.C. board

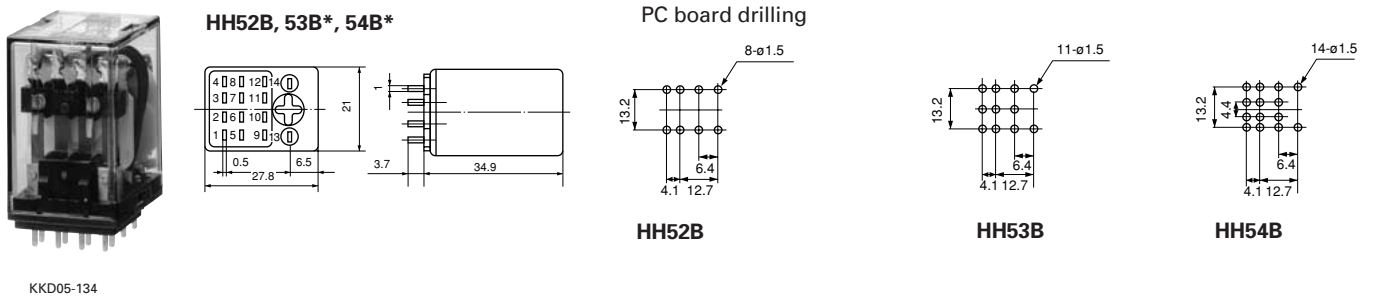

* Number of terminals are different from HH52B.

Flange

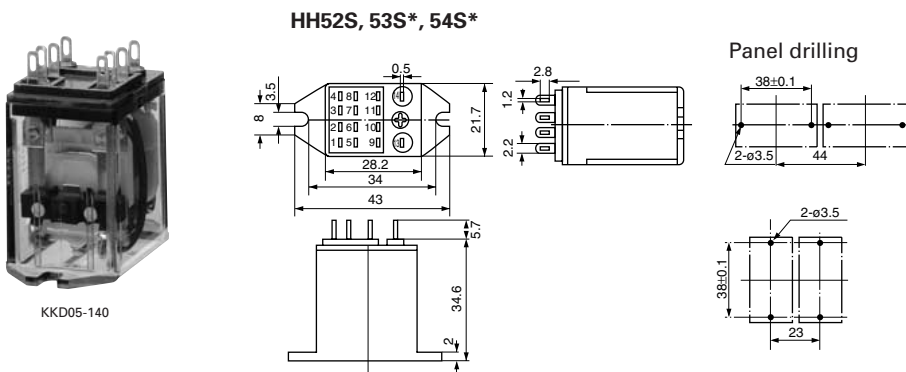

* Number of terminals are different from HH52S.

■ Wiring diagrams

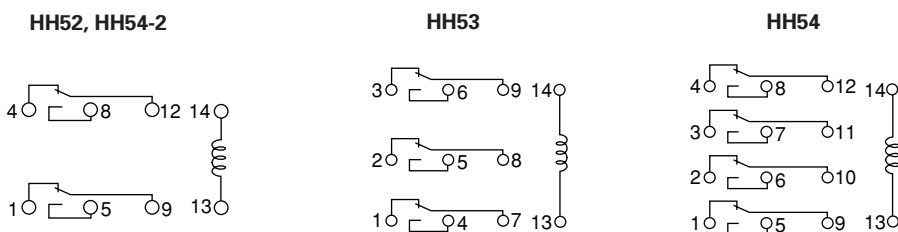

Industrial Control Relays

Miniature control relays

HH52, 53, 54

■ Dimensions, mm/Sockets

Soldering

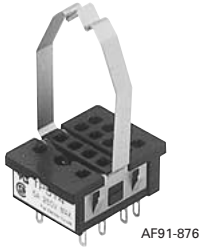

TP511

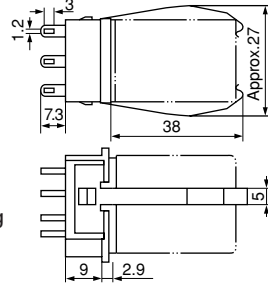
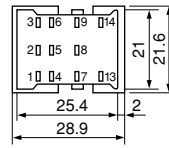

Mass: Approx. 10g

Panel cutting

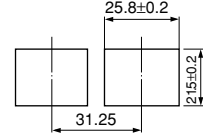

TP58

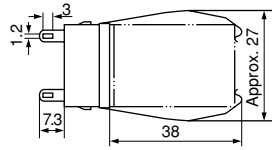
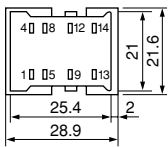

Mass: Approx. 10g

TP514

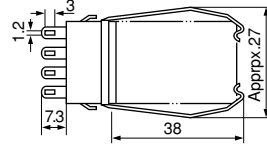
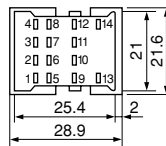

Mass: Approx. 10g

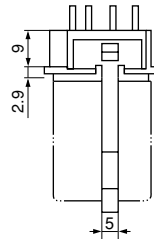
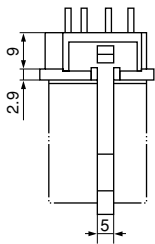

P.C. board



TP58B, TP511B, TP514B

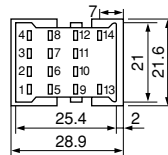

PC board drilling

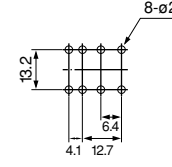

TP58B

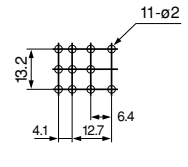

TP511B

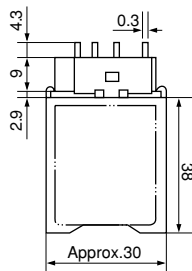

Mass: 58B Approx. 9g
511B, 514B Approx. 9.5g

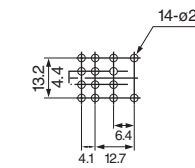

TP514B

Wire-wrap



TP58R2

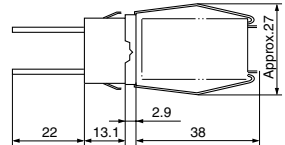
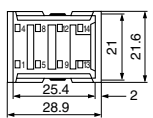

TP511R2

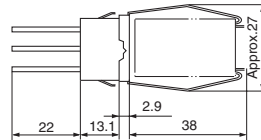
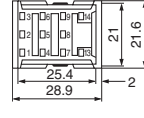

TP514R2

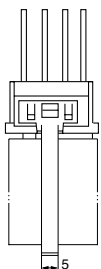
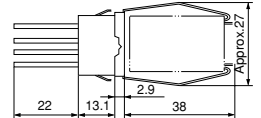
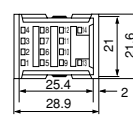

Mass: Approx. 10.5g

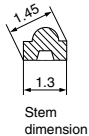

Stem dimension

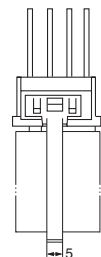

Mass: Approx. 11.5g

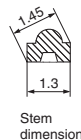

Stem dimension

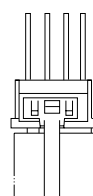

Mass: Approx. 12.5g

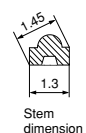

Stem dimension

Panel cutting

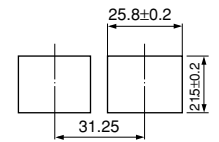

Mounting plates

FUJI can supply very convenient mounting plates which can accept either 1, 16, 18, 19, or 36 panel mounting miniature relays.

These mounting plates use plug-in relays with sockets, which are held in position by "snap-in" clips.

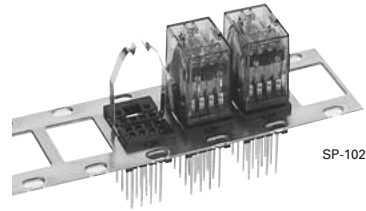

TX01

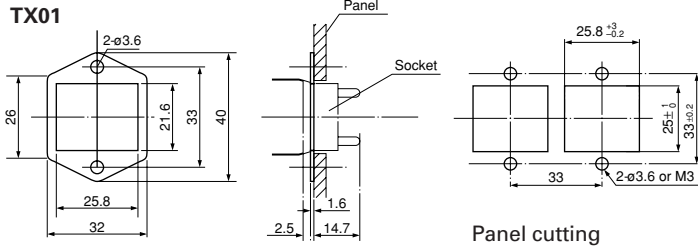

Mass: Approx. 5.8g

TX16, TX19

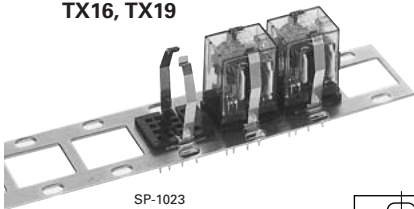

Mass: TX16 Approx. 130g
 TX19 Approx. 160g

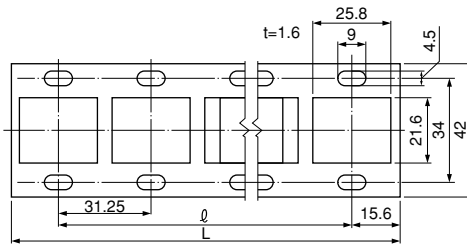

Panel cutting

Description	Type	
	TX16	TX19
Hole	16	19
L distance	500	594
ℓ distance	468.7	562.5

TX18C

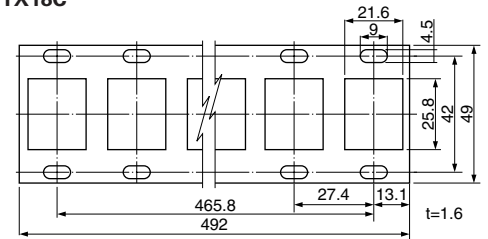

Mass: Approx. 155g

TX36C1

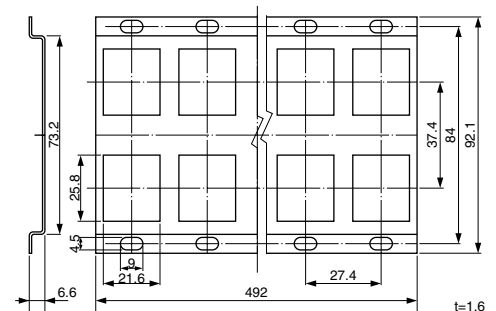

Mass: Approx. 325g

● **Finger protection covers**

- Quick-mounting type cover
 The cover can be quickly mounted on or removed from the TP series socket used with HH series control relay, even if sockets are mounted side-by-side.
- Mountable any time
 The cover can be mounted on or removed from the socket at any time before or after wiring the terminals.

■ **Types**

Type	Used with
RZ52X1	TP58X1 Socket for HH52P miniature control relay
RZ54X1	TP514X1 Socket for HH54P miniature control relay
FX14X2	TP58X2 socket for HH52P miniature control relay TP514X2 socket for HH54P miniature control relay

■ **Dimensions, mm**

RZ52X1

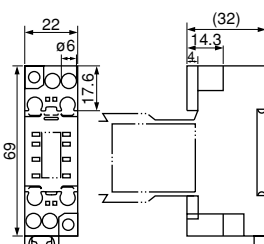

Mass: Approx. 2g

RZ54X1

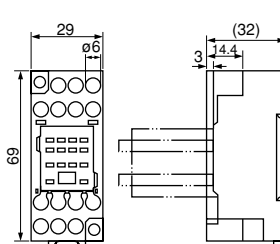

Mass: Approx. 2.5g

FX14X2

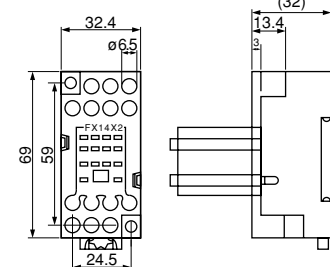

Mass: Approx. 2.7g

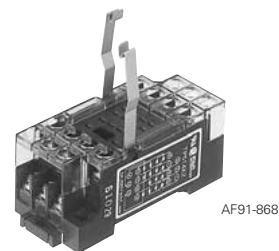

FX14X2

Industrial Control Relays

Miniature control relays

HH52, 53, 54

■ Dimensions, mm

Socket for rail mounting

● Screw terminal M3.5

TP58X2 (for HH52P)

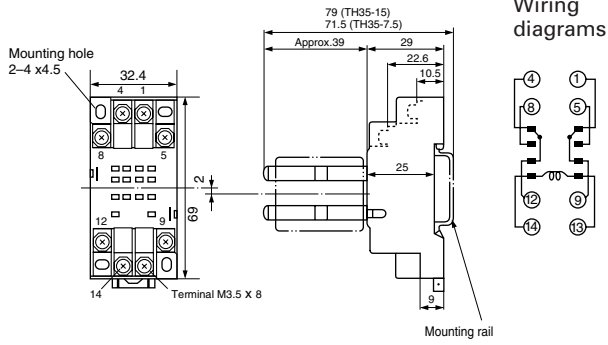

Mass: 49g

TP511X2 (for HH53P)

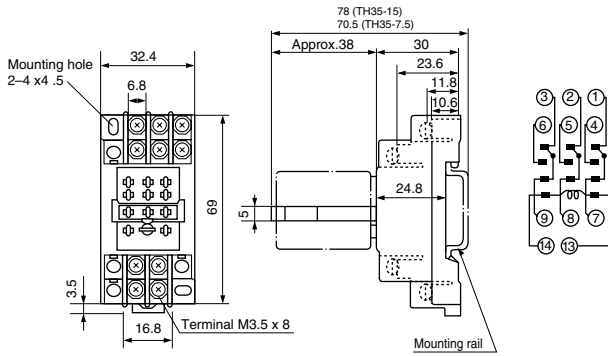

Mass: 50g

TP514X2 (for HH54P)

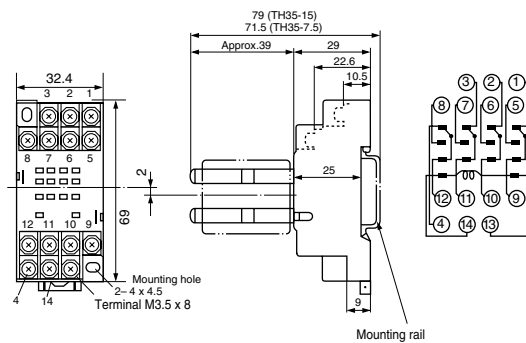

Mass: 62g

● Screw terminal M3

TP58X1 (for HH52P)

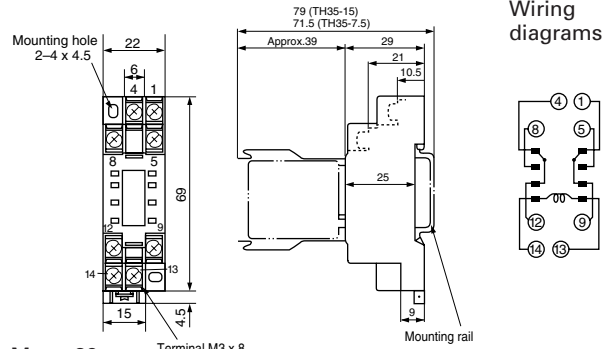

Mass: 32g

TP514X1 (for HH54P)

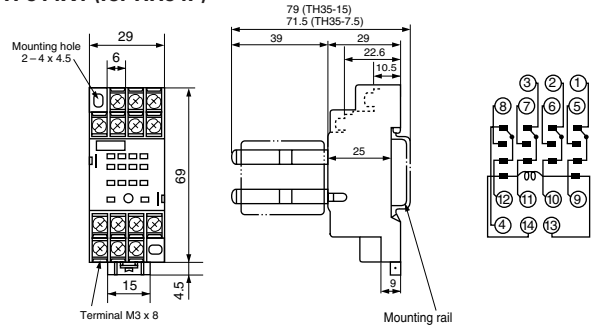

Mass: 49g

● Mounting rails

TH35-7.5

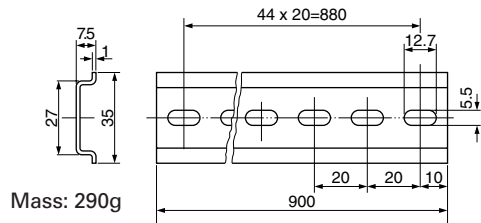

Mass: 290g

TH35-7.5AL

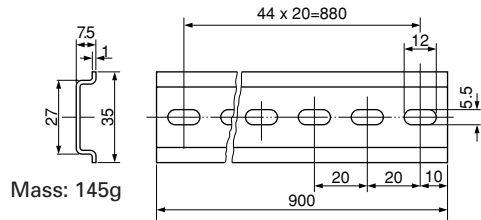

Mass: 145g

TH35-15AL

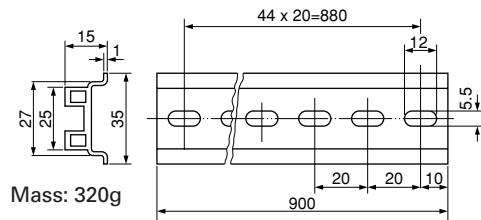

Mass: 320g