

Cam Type RC310 Control selector switches

Cam-type control selector switches

■ Description

FUJI cam-type control switches are recommended for use on switchboards, control panels and switchgear because of their reliability in service. The main type is RC310 with operational current ratings of 10.

Simplified and economical circuits can be designed around the RC310, since it can handle loads of up to 10A at 220VAC without the need of contactors. Typical examples of complex circuits based on the attractive features of these economical cam-type selector switches are given on pages 04/216 to 04/219.

FUJI is prepared to manufacture other versions to suit your particular applications, and switches with up to 12 selector positions can be made to order. RC310 switches are normally supplied with H-type handles. Alternative handle shapes available include the pistol-grip P-type, cane-handle shaped S-type and rosette shaped R-type.

Switches with a 2-12 position maintained type, 3-position center spring-return type and center spring-return type with locking device are also available.

■ Ordering information



Specify the following (See page 04/214):

1. Type number
2. Mounting method
3. Operation
4. Selector position and notch angles
5. No. of contact blocks
6. Contact arrangement
7. Handle
8. Handle colors

■ Example

Cam switch,
 rated current 10A RC310-1
 Flush mounting x
 Maintained operation M
 Contact arrangement 3201
 (3-position, 2 contact blocks,
 H type handle H
 Black color handle..... B
 Type number RC310x-1M3201HB

Note: "C" in the type No. nomenclature must be filled with numbers appearing in the table of "The Contact Arrangement". (page 04/215)
 When requiring special arrangements not appearing in the list clearly specify the arrangement required.
 Note that "C" in the type nomenclature must not be removed in this case.
 RC310x-1M□HB

Type	Flush mounting x-type	Semi-flush mounting e-type	Enclosed g-type
RC310-1	 SG-740 RC310x-1	 SG-743 RC310-1	 AF-191 RC310g-1

■ Ratings

Type	Rated thermal current (A)	Breaking capacity (A) Voltage (V)	Breaking capacity (A)		
			AC Inductive	DC Resistive	DC Inductive
RC310-1	10	24	10	10	5
		110	7.5	3	1.3
		220	7.5	0.8	0.45
		440	2.5	0.4	0.2
		550	2	0.3	0.15

■ Technical data

Insulation resistance: Over 100MΩ at 500VDC
 Dielectric strength: 2,500VAC rms. 1 minute
 Ambient temperature: -5° to +60°C
 Operating cycle: 600 cycles/hour

■ Life expectancy (operations)

Type	Mechanical	Electrical
RC310-1	5 million	250,000 at 220VAC 7.5A 500,000 at 220VAC 3A

■ Contact arrangement: See page 04/216.

■ Contact arrangement (typical)

(Viewed from the direction of the handle)

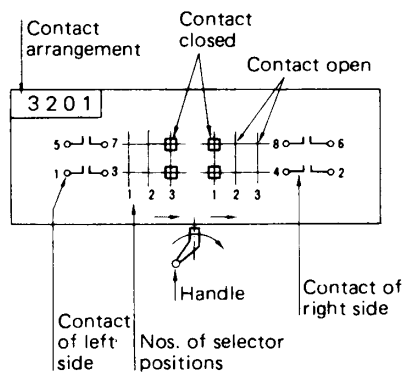

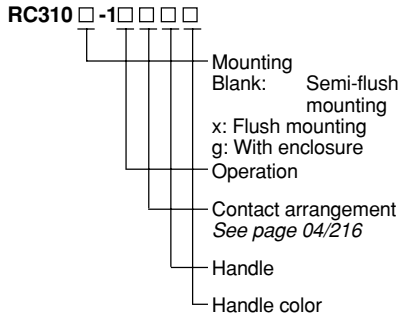

■ **Type number nomenclature**

RC310 series

















- **Handle color** B: Black (Standard)
D: Dark green
R: Red

● **Operation**

Model	Description
M	Maintained
A	Center spring return 
L	Center spring return with locking device (Pull to turn) 

● **Selector position and notch angle**

Operation	Notch angle	Position
M	90° 2 position	
	90° * 3, 4 position	 
	45° * 3-8 position	     
	30° 9-12 position	   
A	45°	
L	45°	 (With locking device)

● Available

Note: * 3 or 4-position type notch angle is normally 45 degrees. Specify when ordering other than this.

● Available

● **Handle**

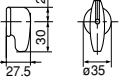
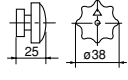
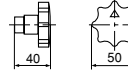
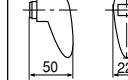
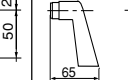
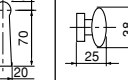
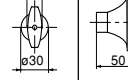
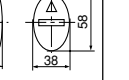
Type	Standard	Versions						
RC310-1	H1 type	R type	W type	S type	P type	K type	D type	G type
								

● **Ratings**

Type	Rated thermal current (A)	Voltage (VAC)	Number of contact blocks	Selector position and notch angle	Flush mounting (x-type) Type	Semi-flush mounting Type	Enclosed (g-type) Type
RC310-1	10	550	1	See the table above.	RC310x-1□■	RC310-1□■	RC310g-1□■
					RC310x-1□■	RC310-1□■	RC310g-1□■
					RC310x-1□■	RC310-1□■	RC310g-1□■
					RC310x-1□■	RC310-1□■	RC310g-1□■
					RC310x-1□■	RC310-1□■	RC310g-1□■
					RC310x-1□■	RC310-1□■	RC310g-1□■
					RC310x-1□■	RC310-1□■	RC310g-1□■
					RC310x-1□■	RC310-1□■	RC310g-1□■
					RC310x-1□■	RC310-1□■	RC310g-1□■
					RC310x-1□■	RC310-1□■	RC310g-1□■

Note: □: Type of operation ■: Contact arrangement – See page 04/216.

Cam Type RC310 Control selector switches

■ Contact arrangement

The following diagrams show the cam-type selector switch contact arrangement. These are only typical examples and other versions can be manufactured to meet your special requirements. Contact FUJI for details.
The figures appearing on the right side indicate the contact arrangement. This information must be given when ordering.

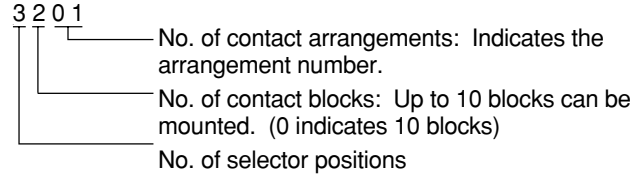

2-position 1-contact block

2101 	2102 	2103 	2104
2105 	2106 	2107 	2108

2-position 2-contact block

2201 	2202 	2203 	2204
2205 	2206 	2207 	2208

2-position 3-contact block

2301 	2302 	2303 	2304
2305 	2306 	2307 	2308

2-position 4-contact block

2401 	2402 	2403 	2404
2405 	2406 	2407 	2408

■ Contact arrangement
3-position 1-contact block

3101 	3102 	3103 	3104
3105 	3106 	3107 	3108
3109 	3110 	3111 	3112

04

3-position 2-contact block

3201 	3202 	3203 	3204
3205 	3206 	3207 	3208
3209 	3210 	3211 	3212

3-position 3-contact block

3301 	3302 	3303 	3304
3305 	3306 	3307 	3308
3309 	3310 	3311 	3312

Cam Type RC310 Control selector switches

■ Contact arrangement 4-position 2-contact block

<p>4201</p>	<p>4202</p>	<p>4203</p>	<p>4204</p>
<p>4205</p>	<p>4206</p>	<p>4207</p>	<p>4208</p>
<p>4209</p>	<p>4210</p>	<p>4211</p>	<p>4212</p>

4-position 3-contact block

<p>4301</p>	<p>4302</p>	<p>4303</p>	<p>4304</p>
<p>4305</p>	<p>4306</p>	<p>4307</p>	<p>4308</p>
<p>4309</p>	<p>4310</p>	<p>4311</p>	<p>4312</p>

4-position 4-contact block

<p>4401</p>	<p>4402</p>	<p>4403</p>	<p>4404</p>
<p>4405</p>	<p>4406</p>	<p>4407</p>	<p>4408</p>
<p>4409</p>	<p>4410</p>	<p>4411</p>	<p>4412</p>

■ Contact arrangement
5-position 2-contact block

5201	5202	5203
5204	5205	5206
5207	5208	5209

04

5-position 3-contact block

5301	5302	5303
5304	5305	5306
5307	5308	5309

5-position 4-contact block

5401	5402	5403
5404	5405	5406
5407	5408	5409

Cam Type RC310 Control selector switches

■ Dimensions, mm

Flush mounting RC310x-1

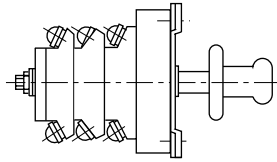

No. of contact blocks	1	2	3	4	5	6	7	8	9	10
L	39.5	51.5	63.5	75.5	87.5	99.5	111.5	123.5	135.5	147.5

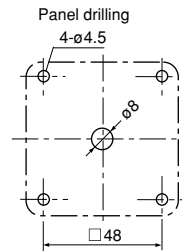
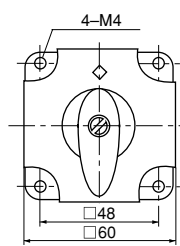
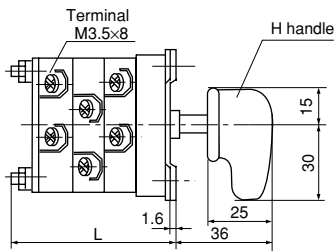

Semi-flush mounting RC310-1

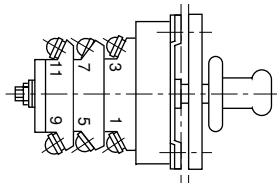

No. of contact blocks	1	2	3	4	5	6	7	8	9	10
L	39.5	51.5	63.5	75.5	87.5	99.5	111.5	123.5	135.5	147.5

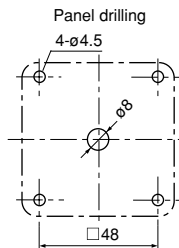
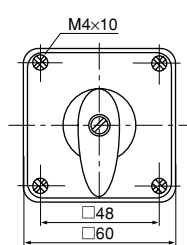
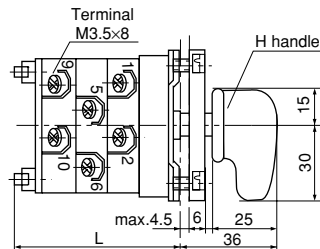

Enclosed (Up to 3-contact block) RC310g-1

